

# AMERICAN FYRE DESIGNS™

outdoor products collection



American Fyre Designs™ • 2022 Product Catalog • RH Peterson Co.



RH PETERSON co.

CRAFTED WITH PRIDE  IN THE USA





# AMERICAN FYRE DESIGNS™

Outdoor Products Collection

Homeowners all over the country have come to realize the allure of fire in their backyards. Fire brings warmth, glow and serenity, encouraging us to relax and unwind. An American Fyre Designs™ exterior fire feature will anchor your outdoor living space and turn your patio into an outdoor sanctuary inviting conversation that flows well into the night – even when there is chill in the air.

From Fireplaces perfect for cuddling up under the stars, to Firetables ideal for entertaining, each product is expertly crafted from innovative glass fiber reinforced concrete (GFRC). GFRC derives its strength from portions of alkali-resistant glass fiber and acrylic polymer blended into durable concrete to withstand the outdoor elements. Modularly constructed for easy assembly, American Fyre Designs™ products are an elegant addition to any outdoor area.

American Fyre Designs™ products are available in a variety of styles, colors and textures to complement any décor. Warm your outdoor living area with American Fyre Designs™.

# Fireplaces

## Recessed Option

Fireplaces may be ordered with recessed hearth and/or body to accommodate field cladding in tile, stone, or other veneer. These recessed vertical surfaces are unfinished.



Reduced Cordova Fireplace with slate tile veneer



Mariposa Fireplace with stacked stone veneer

Pictured above: Grand Mariposa Fireplace (868-05-N-CB-xxC) in Café Blanco Finish with Charred Oak log set (CHDG45-24).

# Fireplaces

Create enticing outdoor ambiance with an American Fyre Designs™ Outdoor Fireplace. Expertly handcrafted from innovative glass fiber reinforced concrete (GFRC), a variety of styles, finishes, and options are available to select the right fireplace for you.

The Grand Series Fireplaces incorporate wall extension panels to create a more impressive design while keeping the same style and look of the fireplace. Wall extension panels expand upon the body of the Fireplace to create many new decorating opportunities while also providing a beautiful separation to the world behind the fireplace.

Most fireplaces are available in vent-free versions which permit you to locate your fireplace in a lanai or other covered outdoor area.



## Grand Cordova Fireplace

Model shown: **882-35-N-WA-xxC\*** // Finish: WA, White Aspen

- Dimensions: 110" w x 41" d x 95" h
- Includes Rectangle Extended Bullnose Hearth

MODEL #	DESCRIPTION
<b>882-35-x-xx-xxC</b>	Vented Fireplace
<b>182-35-x-xx-xxC</b>	Vent-Free Fireplace



## Grand Phoenix Fireplace

Model shown: **818-05-N-CB-xxC\*** // Finish: CB, Café Blanco

- Dimensions: 113" w x 36" d x 87" h
- Includes Extended Bullnose Hearth

MODEL #	DESCRIPTION
<b>818-05-x-xx-xxC</b>	Vented Fireplace
<b>118-05-x-xx-xxC</b>	Vent-Free Fireplace

## Feature Highlights

- Modularly constructed as easy-to-assemble components
- Exterior may be recessed to accommodate field cladding in tile, stone, or other veneer
- Most fireplaces available as Vented or Vent-Free
- All Vent-Free fireplaces are blocked at the top and throat of the firebox
- Most Fireplaces include herringbone firebox liners (excluding Brooklyn and Manhattan models)



## Grand Mariposa Fireplace

Model shown: **868-05-N-CB-xxC\*** // Finish: CB, Café Blanco

- Dimensions: 113" w x 36" d x 67" h
- Includes Extended Bullnose Hearth

MODEL #	DESCRIPTION
<b>868-05-x-xx-xxC</b>	Vented Fireplace
<b>168-05-x-xx-xxC</b>	Vent-Free Fireplace



## Grand Petite Cordova Fireplace

Model shown: **865-10-N-SM-xxC\*** // Finish: SM, Smoke

- Dimensions: 127" w x 36" d x 84" h
- Includes Extended Bullnose Hearth

MODEL #	DESCRIPTION
<b>865-10-x-xx-xxC</b>	Vented Fireplace
<b>165-10-x-xx-xxC</b>	Vent-Free Fireplace

Fireplace venting options **V** = Vented **VF** = Vent Free

\*Vented models shown. See local dealer for information on Vent-Free Fireplaces.

See pages 26 - 29 for available media, page 33 for accessories and page 35 for finish options.



## Cordova Fireplace

Model shown: **022-20-N-CB-xxC\*** // Finish: CB, Café Blanco

- Dimensions: 76" w x 41" d x 95" h
- Pictured with 16" Rectangle Bullnose Hearth

MODEL #	DESCRIPTION
<b>022-xx-x-xx-xxC</b>	Vented Fireplace
<b>122-xx-x-xx-xxC</b>	Vent-Free Fireplace



## Reduced Cordova Fireplace

Model shown: **023-20-N-CB-xxC\*** // Finish: CB, Café Blanco

- Dimensions: 76" w x 41" d x 82" h
- Pictured with 16" Rectangle Bullnose Hearth

MODEL #	DESCRIPTION
<b>023-xx-x-xx-xxC</b>	Vented Fireplace
<b>123-xx-x-xx-xxC</b>	Vent-Free Fireplace



## Petite Cordova Fireplace

Model shown: **025-01-N-CB-xxC\*** // Finish: CB, Café Blanco

- Dimensions: 65" w x 36" d x 84" h
- Pictured with 16" Radioused Bullnose Hearth

MODEL #	DESCRIPTION
<b>025-xx-x-xx-xxC</b>	Vented Fireplace
<b>125-xx-x-xx-xxC</b>	Vent-Free Fireplace



## Mariposa Fireplace

Model shown: **073-01-N-CB-xxC\*** // Finish: CB, Café Blanco

- Dimensions: 65" w x 36" d x 67" h
- Pictured with 16" Radioused Bullnose Hearth

MODEL #	DESCRIPTION
<b>073-xx-x-xx-xxC</b>	Vented Fireplace
<b>173-xx-x-xx-xxC</b>	Vent-Free Fireplace



## Phoenix Fireplace

Model shown: **017-01-N-SM-xxC\*** // Finish: SM, Smoke

- Dimensions: 65" w x 36" d x 87" h
- Pictured with 16" Radioused Bullnose Hearth

MODEL #	DESCRIPTION
<b>017-xx-x-xx-xxC</b>	Vented Fireplace
<b>117-xx-x-xx-xxC</b>	Vent-Free Fireplace



## Manhattan Fireplace

Model shown: **082-SB-N-CB-M3xC** // Finish: Café, Blanco  
// Shelf finish: SB, Smooth Black

- Dimensions: 59" w x 32" d x 42" h
- Includes Mirror Stainless Steel Liner

MODEL #	DESCRIPTION	NG (Btu)	LP (Btu)
<b>082-xx-N-xx-M3xC</b>	Vented Fireplace	40,000	40,000

Propane model is equipped with an access door to house a 5 gal. LP tank inside the unit (not included).

\*Vented models shown. See local dealer for information on Vent-Free Fireplaces.

Fireplace venting options = Vented = Vent Free

See pages 26 - 29 for available media, page 33 for accessories and page 35 for finish options.



## Brooklyn Fireplace

Model shown: **050-CG-N-FO-xxC** \* // Mantel finish: FO, French Barrel Oak

- Overall Dimensions: 68" w x 38" d x 68½" h
- Mantel Dimensions: 68" w x 7" d x 7" h
- "Board-Form" texture on face and hearth sections
- Smooth black interior firebox liners
- Body available in Concrete Grey (CG) finish only

MODEL #	DESCRIPTION	MANTEL COLOR
<b>050-CG-N-FO-xxC</b>	Vented Fireplace	French Barrel Oak
<b>150-CG-N-FO-xxC</b>	Vent-Free Fireplace	French Barrel Oak
<b>050-CG-N-SP-xxC</b>	Vented Fireplace	Silver Pine
<b>150-CG-N-SP-xxC</b>	Vent-Free Fireplace	Silver Pine



## Brooklyn Smooth Fireplace

Model shown: **060-CG-N-SP-xxC** \* // Mantel finish: SP, Silver Pine

- Overall Dimensions: 68" w x 38" d x 68½" h
- Mantel Dimensions: 68" w x 7" d x 7" h
- Add your own stone veneer for a custom look
- Smooth black interior firebox liners
- Body available in Concrete Grey (CG) finish only

MODEL #	DESCRIPTION	MANTEL COLOR
<b>060-CG-N-FO-xxC</b>	Vented Fireplace	French Barrel Oak
<b>160-CG-N-FO-xxC</b>	Vent-Free Fireplace	French Barrel Oak
<b>060-CG-N-SP-xxC</b>	Vented Fireplace	Silver Pine
<b>160-CG-N-SP-xxC</b>	Vent-Free Fireplace	Silver Pine



## Contractor's Model w/ Moulding

Model shown: **045-11-A-WC-RBC** \* // Finish: WC, White Concrete

- Dimensions: 67" w x 37" d x 91" h
- Add your own stone veneer for a custom look
- Available in White Concrete (WC) Only

MODEL #	DESCRIPTION
<b>045-11-A-WC-RBC</b>	Vented Fireplace
<b>145-11-A-WC-RBC</b>	Vent-Free Fireplace



## Contractor's Model Fireplace

Model shown: **040-11-A-WC-RBC** \* // Finish: WC, White Concrete

- Dimensions: 67" w x 37" d x 96" h
- Add your own stone veneer for a custom look
- Available in White Concrete (WC) only

MODEL #	DESCRIPTION
<b>040-11-A-WC-RBC</b>	Vented Fireplace
<b>140-11-A-WC-RBC</b>	Vent-Free Fireplace



The Contractor's Model comes with an unfinished surface to customize the exterior in your choice of surface veneer.

Contractor's Model Fireplace with stone veneer

Fireplace venting options **V** = Vented **VF** = Vent Free

# Firetables

## Firetables

Our Firetables create the perfect ambiance for enjoying an outdoor meal or cocktail while also keeping you warm from the evening chill.

Fuel options include Natural Gas or self-contained Propane tank (most include a removable door to house a 5 gallon Propane tank inside).

### Manual Flame Sensing Control System

Match-lit, thermocouple equipped control with flame sensing recognition and manual flame height adjustment; if the thermocouple does not sense the presence of flame the gas will shut off regardless of valve position.

### Glass Wind Guards

Available for most Firetables (see pg. 34)



*Pictured above: Iron Saddle Firetable (580-TR-11-M7xC) in Travertine Antique Finish with Spheres and Lava Granules.*



## Feature Highlights

- Handcrafted from innovative Glass Fiber Reinforced Concrete (GFRC)
- Stainless steel burners
- Optional 110V FyreStarter Bluetooth Control (Available on Contempo, Versailles, Cosmopolitan, & Milan firetables only)
- Manual Flame Sensing Control Valve
- Access door with Tank Retention Frame to accommodate a 5 gal. LP tank inside the unit (Excluding Contempo, Versailles, Calais, & Milan Firetables)
- Adjustable flame height for comfortable dining
- Available for Natural Gas or Propane



### FyreStarter Bluetooth Control

This convenient new ON/OFF-High/Low electronic system allows you to use your smart phone to control your American Fyre Designs fire feature. Just download the app and you're ready to go. Or manually control at the appliance. (Available on Contempo, Versailles, Cosmopolitan, & Milan firetables)



### Tank Retention Frame

(Featured on products with Tank Access Door)  
Propane units that accept an LP tank include a steel retention frame to secure the tank in place and prevent rust by keeping the tank 2" above the ground. Leveling legs facilitate fine adjustment on uneven surfaces.



### Cosmopolitan Round Firetable

Model shown: **645-DB-11-M2xC** // Finish: DB, Dark Basalt

- Dimensions: 48" diameter x 24" h
- 12" star stainless steel burner
- Accepts a 5 gal. LP tank inside the unit (not included)

MODEL #	CONTROL VALVE	NG (Btu)	LP (Btu)
<b>645-xx-11-M2xC</b>	Manual Flame Sensing	60,000	60,000
<b>645-xx-11-H2xC</b>	FyreStarter Bluetooth†	65,000	65,000



### Cosmopolitan Square Firetable

Model shown: **640-SM-11-M2xC** // Finish: SM, Smoke

- Dimensions: 36" w x 36" d x 24" h
- 12" star stainless steel burner
- Accepts a 5 gal. LP tank inside the unit (not included)

MODEL #	CONTROL VALVE	NG (Btu)	LP (Btu)
<b>640-xx-11-M2xC</b>	Manual Flame Sensing	60,000	60,000
<b>640-xx-11-H2xC</b>	FyreStarter Bluetooth†	65,000	65,000



### Cosmopolitan Rectangle Firetable

Model shown: **635-DB-11-M4xC** // Finish: DB, Dark Basalt

- Dimensions: 54" w x 36" d x 24" h
- 24" linear stainless steel burner
- Accepts a 5 gal. LP tank inside the unit (not included)

MODEL #	CONTROL VALVE	NG (Btu)	LP (Btu)
<b>635-xx-11-M4xC</b>	Manual Flame Sensing	60,000	60,000
<b>635-xx-11-H4xC</b>	FyreStarter Bluetooth†	65,000	65,000

† Fire Bowls with FyreStarter Bluetooth Control require 120V AC power.



### Cosmopolitan Square Din. Firetable

Model shown: **642-SM-11-M6xC** // Finish: SM, Smoke

- Dimensions: 60" w x 60" d x 29" h
- 16" star stainless steel burner
- Accepts a 5 gal. LP tank inside the unit (not included)

MODEL #	CONTROL VALVE	NG (Btu)	LP (Btu)
<b>642-xx-11-M6xC</b>	Manual Flame Sensing	65,000	65,000
<b>642-xx-11-H6xC</b>	FyreStarter Bluetooth†	75,000	75,000



### Amphora Firetable

Model shown: **610-SM-11-M2xC** // Finish: SM, Smoke

- Dimensions: 48" diameter x 24" h
- 12" star stainless steel burner
- Accepts a 5 gal. LP tank inside the unit (not included)

MODEL #	CONTROL VALVE	NG (Btu)	LP (Btu)
<b>610-xx-11-M2xC</b>	Manual Flame Sensing	60,000	60,000



### Inverted Firetable

Model shown: **629-BA-11-M2xC** // Finish: BA, Black Lava

- Dimensions: 48" diameter x 24" h
- 12" star stainless steel burner
- Accepts a 5 gal. LP tank inside the unit (not included)

MODEL #	CONTROL VALVE	NG (Btu)	LP (Btu)
<b>629-xx-11-M2xC</b>	Manual Flame Sensing	60,000	60,000



### Voro Firetable

Model shown: **725-BA-11-M2xC** // Finish: BA, Black Lava

- Dimensions: 36" w x 36" d x 24" h
- 12" star stainless steel burner
- Accepts a 5 gal. LP tank inside the unit (not included)

MODEL #	CONTROL VALVE	NG (Btu)	LP (Btu)
<b>725-xx-11-M2xC</b>	Manual Flame Sensing	60,000	60,000



### Voro Cube

Model shown: **726-BA-11-M2xC** // Finish: BA, Black Lava

- Dimensions: 25½" w x 25½" d x 22¾" h
- 12" star stainless steel burner
- Accepts a 5 gal. LP tank inside the unit (not included)

MODEL #	CONTROL VALVE	NG (Btu)	LP (Btu)
<b>726-xx-11-M2xC</b>	Manual Flame Sensing	60,000	60,000



### Fiesta Firetable

Model shown: **770-CB-11-M2xC** // Finish: CB, Café Blanco

- Dimensions: 54" diameter x 25" h
- 12" star stainless steel burner
- Accepts a 5 gal. LP tank inside the unit (not included)
- Fiesta Firetables include nylon cover for LP tank

MODEL #	CONTROL VALVE	NG (Btu)	LP (Btu)
<b>770-xx-11-M2xC</b>	Manual Flame Sensing	60,000	60,000

† Fire Bowls with FyreStarter Bluetooth Control require 120V AC power.



## Fiesta Dining Firetable

Model shown: **775-SM-11-M2xC** // Finish: SM, Smoke

- Dimensions: 54" diameter x 28" h
- 12" star stainless steel burner
- Accepts a 5 gal. LP tank inside the unit (not included)
- Fiesta Firetables include nylon cover for LP tank

MODEL #	CONTROL VALVE	NG (Btu)	LP (Btu)
<b>775-xx-11-M2xC</b>	Manual Flame Sensing	60,000	60,000

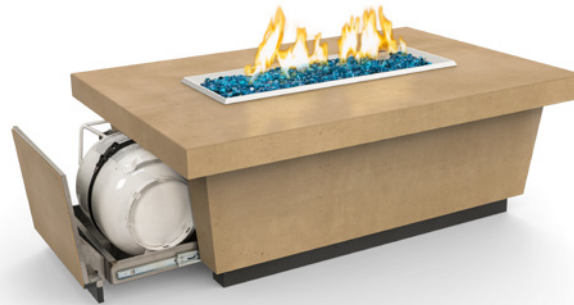

## Contempo LP Select Firetable

Model shown: **785-CB-11-M4PC** // Finish: CB, Café Blanco

- Dimensions: 52" w x 36" d x 18½" h
- 24" linear stainless steel burner
- Convenient tank drawer (Must use horizontal 20# DOT type propane tank)

MODEL #	CONTROL VALVE	NG (Btu)	LP (Btu)
<b>785-xx-11-M4PC</b>	Manual Flame Sensing	60,000	60,000



## Iron Saddle Firetable\*

Model shown: **580-BA-11-M7xC** // Finish: BA, Black Lava

- Dimensions: 60" w x 36" d x 17" h
- 36" linear stainless steel burner

MODEL #	CONTROL VALVE	NG (Btu)	LP (Btu)
<b>580-xx-11-M7xC</b>	Manual Flame Sensing	65,000	65,000
<b>580-xx-11-H7xC</b>	FyreStarter Bluetooth†	75,000	75,000



## Contempo Round Firetable\*

Model shown: **782-DB-11-M2xC** // Finish: DB, Dark Basalt

- Dimensions: 47" diameter x 15½" h
- 12" star stainless steel burner

MODEL #	CONTROL VALVE	NG (Btu)	LP (Btu)
<b>782-xx-11-M2xC</b>	Manual Flame Sensing	60,000	60,000
<b>782-xx-11-H2xC</b>	FyreStarter Bluetooth†	65,000	65,000



## Contempo Square Firetable\*

Model shown: **784-SM-11-M2xC** // Finish: SM, Smoke

- Dimensions: 44" w x 44" d x 15½" h
- 12" star stainless steel burner

MODEL #	CONTROL VALVE	NG (Btu)	LP (Btu)
<b>784-xx-11-M2xC</b>	Manual Flame Sensing	60,000	60,000
<b>784-xx-11-H2xC</b>	FyreStarter Bluetooth†	65,000	65,000



## Contempo Rectangle Firetable\*

Model shown: **783-WA-11-M4xC** // Finish: WA, White Aspen

- Dimensions: 52" w x 36" d x 15½" h
- 24" linear stainless steel burner

MODEL #	CONTROL VALVE	NG (Btu)	LP (Btu)
<b>783-xx-11-M4xC</b>	Manual Flame Sensing	60,000	60,000
<b>783-xx-11-H4xC</b>	FyreStarter Bluetooth†	65,000	65,000

† Fire Bowls with FyreStarter Bluetooth Control require 120V AC power.

\* Cannot accommodate a Propane tank inside the unit, see page 34 for matching tank housing options.



### Milan Tall Linear Firetable\*

Model shown: **215-SM-11-M8xC** // Finish: SM, Smoke

- Dimensions: 72" w x 16" d x 32" h
- 48" linear stainless steel burner

MODEL #	CONTROL VALVE	NG (Btu)	LP (Btu)
<b>215-xx-11-M8xC</b>	Manual Flame Sensing	65,000	65,000
<b>215-xx-11-H8xC</b>	FyreStarter Bluetooth†	100,000	100,000



### Milan Low Linear Firetable\*

Model shown: **216-CB-11-M8xC** // Finish: CB, Café Blanco

- Dimensions: 72" w x 16" d x 16" h
- 48" linear stainless steel burner

MODEL #	CONTROL VALVE	NG (Btu)	LP (Btu)
<b>216-xx-11-M8xC</b>	Manual Flame Sensing	65,000	65,000
<b>216-xx-11-H8xC</b>	FyreStarter Bluetooth†	100,000	100,000



### Calais Oval Firetable\*

Model shown: **759-WA-11-M4xC** // Finish: WA, White Aspen

- Dimensions: 60" w x 36" d x 18" h
- 24" linear stainless steel burner

MODEL #	CONTROL VALVE	NG (Btu)	LP (Btu)
<b>759-xx-11-M4xC</b>	Manual Flame Sensing	60,000	60,000



### Versailles Firetable\*

Model shown: **744-SM-11-M6xC** // Finish: SM, Smoke

- Dimensions: 54" diameter x 16" h
- 16" star stainless steel burner

MODEL #	CONTROL VALVE	NG (Btu)	LP (Btu)
<b>744-xx-11-M6xC</b>	Manual Flame Sensing	65,000	65,000
<b>744-xx-11-H6xC</b>	FyreStarter Bluetooth†	100,000	100,000



### Lotus Firetable\*

Model shown: **653-CB-11-M2xC** // Finish: CB, Café Blanco

- Dimensions: 48" diameter x 20" h
- 12" star stainless steel burner

MODEL #	CONTROL VALVE	NG (Btu)	LP (Btu)
<b>653-xx-11-M2xC</b>	Manual Flame Sensing	60,000	60,000

† Fire Bowls with FyreStarter Bluetooth Control require 120V AC power.

\* Cannot accommodate a Propane tank inside the unit, see page 34 for matching tank housing options.



*Pictured above: Calais Oval Firetable (759-DB-11-M4xC) in Dark Basalt Antique Finish with Desert Sage Branches (BDS-2) and Lava Granules.*



*Pictured Above: Reclaimed Wood Cosmo Square Dining Firetable (642-BA-FO-M6xC) with French Barrel Oak top and Beachwood Logs w/ Stones (OCBW-34).*



### Reclaimed Wood Cosmo Round

Model shown: **645-BA-SP-M2xC** // Table top: SP, Silver Pine

- Dimensions: 48" diameter x 24" h
- 12" star stainless steel burner
- Accepts a 5 gal. LP tank inside the unit (not included)

MODEL #	CONTROL VALVE	NG (Btu)	LP (Btu)
<b>645-BA-xx-M2xC</b>	Manual Flame Sensing	60,000	60,000
<b>645-BA-xx-H2xC</b>	FyreStarter Bluetooth <sup>†</sup>	65,000	65,000

Replace "xx" with table top code: **FO**, French Barrel Oak // **SP**, Silver Pine.

#8510-BA-FO (see pg. 34)



### Reclaimed Wood Contempo Round\*

Model shown: **782-BA-FO-M2xC** // Table top: FO, French Barrel Oak

- Dimensions: 47" diameter x 15½" h
- 12" star stainless steel burner

MODEL #	CONTROL VALVE	NG (Btu)	LP (Btu)
<b>782-BA-xx-M2xC</b>	Manual Flame Sensing	60,000	60,000
<b>782-BA-xx-H2xC</b>	FyreStarter Bluetooth <sup>†</sup>	65,000	65,000

Replace "xx" with table top code: **FO**, French Barrel Oak // **SP**, Silver Pine.



### Reclaimed Wood Cosmo Square

Model shown: **640-BA-SP-M2xC** // Table top: SP, Silver Pine

- Dimensions: 36" w x 36" d x 24" h
- 12" star stainless steel burner
- Accepts a 5 gal. LP tank inside the unit (not included)

MODEL #	CONTROL VALVE	NG (Btu)	LP (Btu)
<b>640-BA-xx-M2xC</b>	Manual Flame Sensing	60,000	60,000
<b>640-BA-xx-H2xC</b>	FyreStarter Bluetooth†	65,000	65,000

Replace "xx" with table top code: **FO**, French Barrel Oak // **SP**, Silver Pine.



### Reclaimed Wood Cosmo Rectangle

Model shown: **635-BA-FO-M4xC** // Table top: FO, French Barrel Oak

- Dimensions: 54" w x 36" d x 24" h
- 24" linear stainless steel burner
- Accepts a 5 gal. LP tank inside the unit (not included)

MODEL #	CONTROL VALVE	NG (Btu)	LP (Btu)
<b>635-BA-xx-M4xC</b>	Manual Flame Sensing	60,000	60,000
<b>635-BA-xx-H4xC</b>	FyreStarter Bluetooth†	65,000	65,000

Replace "xx" with table top code: **FO**, French Barrel Oak // **SP**, Silver Pine.



### Reclaimed Wood Cosmo Sq. Dining

Model shown: **642-BA-FO-M6xC** // Table top: FO, French Barrel Oak

- Dimensions: 60" w x 60" d x 29" h
- 16" star stainless steel burner
- Accepts a 5 gal. LP tank inside the unit (not included)

MODEL #	CONTROL VALVE	NG (Btu)	LP (Btu)
<b>642-BA-xx-M6xC</b>	Manual Flame Sensing	65,000	65,000
<b>642-BA-xx-H6xC</b>	FyreStarter Bluetooth†	75,000	75,000

Replace "xx" with table top code: **FO**, French Barrel Oak // **SP**, Silver Pine.



### Reclaimed Wood Contempo Square\*

Model shown: **784-BA-FO-M2xC** // Table top: FO, French Barrel Oak

- Dimensions: 44" w x 44" d x 15½" h
- 12" star stainless steel burner

MODEL #	CONTROL VALVE	NG (Btu)	LP (Btu)
<b>784-BA-xx-M2xC</b>	Manual Flame Sensing	60,000	60,000
<b>784-BA-xx-H2xC</b>	FyreStarter Bluetooth†	65,000	65,000

Replace "xx" with table top code: **FO**, French Barrel Oak // **SP**, Silver Pine.



### Reclaimed Wood Contempo Rectangle\*

Model shown: **783-BA-SP-M4xC** // Table top: SP, Silver Pine

- Dimensions: 52" w x 36" d x 15½" h
- 24" linear stainless steel burner

MODEL #	CONTROL VALVE	NG (Btu)	LP (Btu)
<b>783-BA-xx-M4xC</b>	Manual Flame Sensing	60,000	60,000
<b>783-BA-xx-H4xC</b>	FyreStarter Bluetooth†	65,000	65,000

Replace "xx" with table top code: **FO**, French Barrel Oak // **SP**, Silver Pine.



### Reclaimed Wood Contempo LP Select

Model shown: **785-BA-SP-M4PC** // Table top: SP, Silver Pine

- Dimensions: 52" w x 36" d x 18½" h
- 24" linear stainless steel burner
- Convenient tank drawer (*Must use horizontal 20# DOT type propane tank*)

MODEL #	CONTROL VALVE	NG (Btu)	LP (Btu)
<b>785-BA-xx-M4PC</b>	Manual Flame Sensing	60,000	60,000

Replace "xx" with table top code: **FO**, French Barrel Oak // **SP**, Silver Pine.

† Fire Bowls with FyreStarter Bluetooth Control require 120V AC power.

\* Cannot accommodate a Propane tank inside the unit, see page 34 for matching tank housing options.

# Fire Bowls



*Pictured above: 36" Fire Bowl (732-CB-11-M6xC) in Café Blanco Finish with Copper Reflective Fyre Glass (2-GL-40-QR).*



*Pictured above: 48" Marseille Fire Bowl (751-BA-80-M6xC) in Black Lava Finish with Lava Coals (LFC-10).*



# Fire Bowls

American Fyre Designs™ Fire Bowls are the hottest trend right now because of their simple, contemporary design and versatility of uses. With a variety of different styles and sizes, these Fire Bowls are easily incorporated into any style or size of outdoor space.

Handcrafted from glass fiber reinforced concrete (GFRC), the Fire Bowls come in a variety of different colors and textures. Choose Natural Gas or Propane.

## Feature Highlights

- Contemporary design
- Handcrafted from innovative Glass Fiber Reinforced Concrete (GFRC)
- Stainless steel burners
- Manual Flame Sensing Control System
- Optional 110V FyreStarter Bluetooth Control (Available on most fire bowls)
- Available for Natural Gas or Propane



### 48" Fire Bowl

Model shown: **731-CB-11-M6xC** // Finish: CB, Café Blanco

- Dimensions: 48" diameter x 22" h
- 16" star stainless steel burner
- Access door with Tank Retention Frame to accommodate a 5 gal. Propane tank inside the unit (tank not included)

MODEL #	CONTROL VALVE	NG (Btu)	LP (Btu)
<b>731-xx-11-M6xC</b>	Manual Flame Sensing	65,000	65,000
<b>731-xx-11-H6xC</b>	FyreStarter Bluetooth†	100,000	100,000



### 36" Fire Bowl\*

Model shown: **732-CB-11-M6xC** // Finish: CB, Café Blanco

- Dimensions: 36" diameter x 16" h
- 16" star stainless steel burner

MODEL #	CONTROL VALVE	NG (Btu)	LP (Btu)
<b>732-xx-11-M6xC</b>	Manual Flame Sensing	65,000	65,000
<b>732-xx-11-H6xC</b>	FyreStarter Bluetooth†	100,000	100,000



### 32" Fire Bowl\*

Model shown: **733-DB-11-M6xC** // Finish: DB, Dark Basalt

- Dimensions: 32" diameter x 16" h
- 16" star stainless steel burner

MODEL #	CONTROL VALVE	NG (Btu)	LP (Btu)
<b>733-xx-11-M6xC</b>	Manual Flame Sensing	65,000	65,000
<b>733-xx-11-H6xC</b>	FyreStarter Bluetooth†	100,000	100,000



### FyreStarter Bluetooth Control

This convenient new ON/OFF-High/Low electronic system allows you to use your smart phone to control your American Fyre Designs fire feature. Just download the app and you're ready to go. Or manually control at the appliance. (Available on most fire bowl models)

\*Cannot accommodate a Propane tank inside the unit, see page 34 for matching tank housing options.

†Fire Bowls with FyreStarter Bluetooth Control require 120V AC power.

See pages 26 - 29 for available media, pages 30, 31, & 34 for accessories and page 35 for finish options.

# Bordeaux Fire Bowls

American Fyre Designs™ Fire Bowls are the hottest trend right now because of their simple, contemporary design and versatility of uses. With a variety of different styles and sizes, these Fire Bowls are easily incorporated into any style or size of outdoor space.

Handcrafted from glass fiber reinforced concrete (GFRC), the Fire Bowls come in a variety of different colors and textures. Choose Natural Gas or Propane.



## Bordeaux Rectangle Fire Bowl\*

Model shown: **435-SM-11-M4xC** // Finish: SM, Smoke

- Dimensions: 50" w x 30" d x 16¼" h
- 24" linear stainless steel burner

MODEL #	CONTROL VALVE	NG (Btu)	LP (Btu)
<b>435-xx-11-M4xC</b>	Manual Flame Sensing	60,000	60,000
<b>435-xx-11-H4xC</b>	FyreStarter Bluetooth†	65,000	65,000

## Bordeaux Square Fire Bowl\*

Model shown: **430-CB-11-M6xC** // Finish: CB, Café Blanco

- Dimensions: 36" w x 36" d x 15¼" h
- 16" star stainless steel burner

MODEL #	CONTROL VALVE	NG (Btu)	LP (Btu)
<b>430-xx-11-M6xC</b>	Manual Flame Sensing	65,000	65,000
<b>430-xx-11-H6xC</b>	FyreStarter Bluetooth†	100,000	100,000



## Reclaimed Wood Bordeaux Sq. Fire Bowl\*

Model shown: **430-FO-FO-M6xC** // Finish: FO, French Barrel Oak

- Dimensions: 36" w x 36" d x 15¼" h
- 16" star stainless steel burner

MODEL #	CONTROL VALVE	NG (Btu)	LP (Btu)
<b>430-xx-xx-M6xC</b>	Manual Flame Sensing	65,000	65,000
<b>430-xx-xx-H6xC</b>	FyreStarter Bluetooth†	100,000	100,000

Replace "xx" with finish code: **FO**, French Barrel Oak // **SP**, Silver Pine.

## Bordeaux Petite Square Fire Bowl\*

Model shown: **431-DB-11-M6xC** // Finish: DB, Dark Basalt

- Dimensions: 30" w x 30" d x 12¼" h
- 16" star stainless steel burner

MODEL #	CONTROL VALVE	NG (Btu)	LP (Btu)
<b>431-xx-11-M6xC</b>	Manual Flame Sensing	65,000	65,000

## Feature Highlights

- Contemporary design
- Handcrafted from innovative Glass Fiber Reinforced Concrete (GFRC)
- Stainless steel burners
- Manual Flame Sensing Control System
- Optional 110V FyreStarter Bluetooth Control (Available on most fire bowls)
- Available for Natural Gas or Propane

\*Cannot accommodate a Propane tank inside the unit, see page 34 for matching tank housing options.

†Fire Bowls with FyreStarter Bluetooth Control require 120V AC power.

See pages 26 - 29 for available media, pages 30, 31, & 34 for accessories and page 35 for finish options.

# Marseille Fire Bowls

The Marseille Fire Bowls feature a low profile design and a wide opening to accommodate more and varied fire media. Handcrafted from glass fiber reinforced concrete (GFRC), these contemporary Fire Bowls come in a variety of different colors and textures. Fuel options include Natural Gas or Propane.

Three sizes are also available with a water spout to combine running water with dancing flames (plumbing must be locally supplied).



## 48" Marseille Fire Bowl\*

Model shown: **751-CB-11-M6xC** // Finish: CB, Café Blanco

- Dimensions: 48" diameter x 10½" h
- 16" star stainless steel burner
- Available with water spout

MODEL #	DESCRIPTION	NG (Btu)	LP (Btu)
<b>751-xx-11-M6xC</b>	Manual Flame Sensing	65,000	65,000
<b>751-xx-80-M6xC</b>	M.F.S.C.S. w/ water spout	65,000	65,000
<b>751-xx-11-H6xC</b>	FyreStarter Bluetooth†	100,000	100,000



## 40" Marseille Fire Bowl\*

Model shown: **752-LB-11-M6xC** // Finish: LB, Light Basalt

- Dimensions: 40" diameter x 11" h
- 16" star stainless steel burner
- Available with water spout

MODEL #	DESCRIPTION	NG (Btu)	LP (Btu)
<b>752-xx-11-M6xC</b>	Manual Flame Sensing	65,000	65,000
<b>752-xx-80-M6xC</b>	M.F.S.C.S. w/ water spout	65,000	65,000
<b>752-xx-11-H6xC</b>	FyreStarter Bluetooth†	100,000	100,000

## Feature Highlights

- Contemporary design
- Handcrafted from innovative Glass Fiber Reinforced Concrete (GFRC)
- 16" stainless steel burner
- Manual Flame Sensing Control System
- Optional 110V FyreStarter Bluetooth Control (Available on most fire bowls)
- Available for Natural Gas or Propane



## 32" Marseille Fire Bowl\*

Model shown: **753-WA-11-M6xC** // Finish: WA, White Aspen

- Dimensions: 32" diameter x 8½" h
- 16" star stainless steel burner
- Available with water spout

MODEL #	DESCRIPTION	NG (Btu)	LP (Btu)
<b>753-xx-11-M6xC</b>	Manual Flame Sensing	65,000	65,000
<b>753-xx-80-M6xC</b>	M.F.S.C.S. w/ water spout	65,000	65,000



## 24" Marseille Fire Bowl\*

Model shown: **755-BA-11-M2xC** // Finish: BA, Black Lava

- Dimensions: 24" diameter x 6½" h
- 12" star stainless steel burner

MODEL #	DESCRIPTION	NG (Btu)	LP (Btu)
<b>755-xx-11-M2xC</b>	Manual Flame Sensing	60,000	60,000

\* Cannot accommodate a Propane tank inside the unit, see page 34 for matching tank housing options.

† Fire Bowls with FyreStarter Bluetooth Control require 120V AC power.

# Lanterns & Fire Urns

## Lanterns & Fire Urns

The versatility of American Fyre Designs' Lanterns and Fire Urns is unmatched. From traditional to contemporary, these unique fire features offer a wide array of design options to any outdoor setting. Several of these can be displayed down a path or placed near a fireplace or other outdoor feature to add sophisticated elegance to your outdoor area.

Made from glass fiber reinforced concrete (GFRC), these fire features come in a variety of different finishes. Fuel options include Natural Gas or self-contained Propane tank.

### Manual Flame Sensing Control System

Match-lit, thermocouple equipped control with flame sensing recognition and manual flame height adjustment; if the thermocouple does not sense the presence of flame the gas will shut off regardless of valve position.

## Feature Highlights

- Contemporary design
- Handcrafted from innovative Glass Fiber Reinforced Concrete (GFRC)
- Stainless steel burner
- Manual Flame Sensing Control System
- Optional 110V FyreStarter Bluetooth Control (Available on Lanterns)
- Available for Natural Gas or Propane
- Removable door to house a 5 gal. Propane tank

*Pictured above: Magnolia Lantern (716-BA-11-M1xC) in Black Lava finish.*

*Pictured above: Eclipse Fire Urn (520-WA-11-M2xC) in White Aspen finish with Black Reflective Fyre Glass (GL-xx-BR).*



**NEW!**

### FyreStarter Bluetooth Control

This convenient new ON/OFF-High/Low electronic system allows you to use your smart phone to control your American Fyre Designs fire feature. Just download the app and you're ready to go. Or manually control at the appliance. (Available on Lanterns)

† Lanterns with FyreStarter Bluetooth Control require 120VAC power.



### Piage Fire Urn & Pedestal

Model shown: **765-CB-11-M2xC** // Finish: CB, Café Blanco

- Dimensions: 26" w x 19" d x 58" h
- 12" star stainless steel burner
- Accepts a 5 gal. LP tank inside the unit (not included)

MODEL #	CONTROL VALVE	NG (Btu)	LP (Btu)
<b>765-xx-11-M2xC</b>	Manual Flame Sensing	60,000	60,000



### Nest Lantern

Model shown: **715-CB-11-M1xC** // Finish: CB, Café Blanco

- Dimensions: 16" w x 16" d x 66" h
- Accepts a 5 gal. LP tank inside the unit (not included)

MODEL #	CONTROL VALVE	NG (Btu)	LP (Btu)
<b>715-xx-11-M1xC</b>	Manual Flame Sensing	25,000	23,000
<b>715-xx-11-H1xC</b>	FyreStarter Bluetooth†	28,000	27,000



### Eclipse Fire Urn

Model shown: **520-SM-11-M2xC** // Finish: SM, Smoke

- Dimensions: 23" diameter x 37½" h
- 12" star stainless steel burner
- Available with or without access door for LP tank

MODEL #	DESCRIPTION	NG (Btu)	LP (Btu)
<b>520-xx-11-M2xC</b>	w/ LP tank access door	60,000	60,000
<b>520-xx-10-M2NC</b>	w/o LP tank access door	60,000	--



### Magnolia Lantern

Model shown: **716-BA-11-M1xC** // Finish: BA, Black Lava

- Dimensions: 16" w x 16" d x 66" h
- Accepts a 5 gal. LP tank inside the unit (not included)

MODEL #	CONTROL VALVE	NG (Btu)	LP (Btu)
<b>716-xx-11-M1xC</b>	Manual Flame Sensing	25,000	23,000
<b>716-xx-11-H1xC</b>	FyreStarter Bluetooth†	28,000	27,000



### Wave Fire Urn

Model shown: **530-DB-11-M2xC** // Finish: DB, Dark Basalt

- Dimensions: 20" diameter x 37½" h
- 12" star stainless steel burner
- Available with or without access door for LP tank

MODEL #	DESCRIPTION	NG (Btu)	LP (Btu)
<b>530-xx-11-M2xC</b>	w/ LP tank access door	60,000	60,000
<b>530-xx-10-M2xC</b>	w/o LP tank access door	60,000	--

# Louvre Fire Pits



Pictured above: Louvre Round Fire Pit (686-CB-11-M6xC) in Café Blanco Finish with Lava Granules (LF-10 x 4) and Volcanic Stones (VS-25).

## Louvre Fire Pits

The Louvre Series of Fire Pits brings a sleek, contemporary look to the classic outdoor fire pit. With options such as glass, creekstones, lava coals, or campfire logs, these fire pits can enhance any backyard.

Made from glass fiber reinforced concrete (GFRC), these fire pits come in a variety of different colors. Fuel options include Natural Gas or Propane.

### Feature Highlights

- Handcrafted from innovative Glass Fiber Reinforced Concrete (GFRC)
- Simple design for contemporary décor
- Stainless steel burner
- Manual Flame Sensing Control System
- Optional 110V FyreStarter Bluetooth Control (Available on all Fire Pits)
- Available for Natural Gas or Propane (Propane models, see page 34 for tank housing options)



### FyreStarter Bluetooth Control

This convenient new ON/OFF-High/Low electronic system allows you to use your smart phone to control your American Fyre Designs fire feature. Just download the app and you're ready to go. Or manually control at the appliance.



### Louvre Long Rectangle Fire Pit

Model shown: **688-CB-11-M8xC** // Finish: CB, Café Blanco

- Dimensions: 72" w x 30" d x 15¼" h
- 48" linear stainless steel burner

MODEL #	CONTROL VALVE	NG (Btu)	LP (Btu)
<b>688-xx-11-M8xC</b>	Manual Flame Sensing	65,000	65,000
<b>688-xx-11-H8xC</b>	FyreStarter Bluetooth†	100,000	100,000



### Louvre Rectangle Fire Pit

Model shown: **689-BA-11-M7xC** // Finish: BA, Black Lava

- Dimensions: 56" w x 30" d x 15¼" h
- 36" linear stainless steel burner

MODEL #	CONTROL VALVE	NG (Btu)	LP (Btu)
<b>689-xx-11-M7xC</b>	Manual Flame Sensing	65,000	65,000
<b>689-xx-11-H7xC</b>	FyreStarter Bluetooth†	75,000	75,000



### Louvre Round Fire Pit

Model shown: **686-CB-11-M6xC** // Finish: CB, Café Blanco

- Dimensions: 48" diameter x 15¼" h
- 16" star stainless steel burner

MODEL #	CONTROL VALVE	NG (Btu)	LP (Btu)
<b>686-xx-11-M6xC</b>	Manual Flame Sensing	65,000	65,000
<b>686-xx-11-H6xC</b>	FyreStarter Bluetooth†	100,000	100,000

† Fire Pits with FyreStarter Bluetooth Control require 120V AC power.

See pages 26 - 29 for available media, pages 30, 31, & 34 for accessories and page 35 for finish options.

# Fire Pits



*Pictured above: Contractor's Model Fire Pit (685-CB-11-M6xC) in Café Blanco Finish w/stone veneer.*



## Fire Pits

Our artistically-designed fire pits add style and design to the classic outdoor fire pit. The Chiseled Fire Pit has a rough hewn concrete exterior and smooth rim around the top. The El Dorado Fire Pit has a smooth concrete exterior and smooth rim around the top. The Contractor's Model comes as a blank slate for you to customize and design your way by adding your own stone, tile, or other veneer. Made from glass fiber reinforced concrete (GFRC), these fire pits come in a variety of different colors. Fuel options include Natural Gas or Propane.

### Feature Highlights

- Handcrafted from innovative Glass Fiber Reinforced Concrete (GFRC)
- 16" stainless steel burner
- Manual Flame Sensing Control System
- New "reversible floor" design to suit your décor needs
- Optional 110V FyreStarter Bluetooth Control (Available on all Fire Pits)
- Available for Natural Gas or Propane (Propane models, see page 34 for tank housing options)

### "Reversible Floor"

High configuration recommended for higher stack or flame (better for glass).

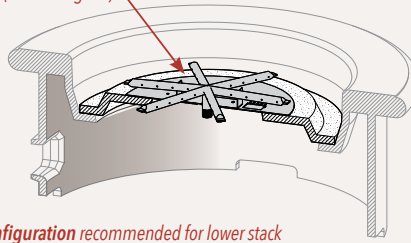

Low configuration recommended for lower stack or flame (better for logs).

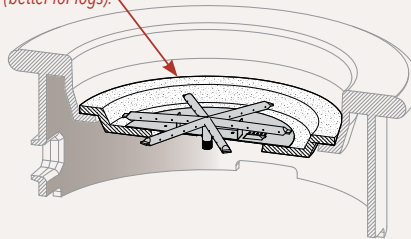

### Contractor's Model Fire Pit

Model shown: **685-CB-11-M6xC** // Finish: CB, Café Blanco

- Dimensions: 39" diameter x 14½" h
- 16" star stainless steel burner
- Add your own stone veneer for a custom look
- Reversible floor to accommodate multiple of media

MODEL #	CONTROL VALVE	NG (Btu)	LP (Btu)
<b>685-xx-11-M6xC</b>	Manual Flame Sensing	65,000	65,000
<b>685-xx-11-H6xC</b>	FyreStarter Bluetooth†	100,000	100,000



### Chiseled Fire Pit

Model shown: **680-CB-11-M6xC** // Finish: CB, Café Blanco

- Dimensions: 39" diameter x 14½" h
- 16" star stainless steel burner
- Reversible floor to accommodate multiple of media

MODEL #	CONTROL VALVE	NG (Btu)	LP (Btu)
<b>680-xx-11-M6xC</b>	Manual Flame Sensing	65,000	65,000
<b>680-xx-11-H6xC</b>	FyreStarter Bluetooth†	100,000	100,000



### El Dorado Fire Pit

Model shown: **681-CB-11-M6xC** // Finish: CB, Café Blanco

- Dimensions: 39" diameter x 14½" h
- 16" star stainless steel burner
- Reversible floor to accommodate multiple of media

MODEL #	CONTROL VALVE	NG (Btu)	LP (Btu)
<b>681-xx-11-M6xC</b>	Manual Flame Sensing	65,000	65,000
<b>681-xx-11-H6xC</b>	FyreStarter Bluetooth†	100,000	100,000



### FyreStarter Bluetooth Control

† Fire Pits with FyreStarter Bluetooth Control require 120V AC power.

See pages 26 - 29 for available media, pages 30, 31, & 34 for accessories and page 35 for finish options.

# Glass Media



## Fyre Glass



**Azuria**  
#GL-xx-F



**Black**  
#GL-xx-B



**Bronze**  
#GL-xx-Z

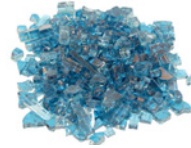

**Caribbean Blue**  
#GL-xx-N



**Clear**  
#GL-xx-C



**Emerald**  
#GL-xx-E



**Star Fyre**  
#GL-xx-W

## Reflective Fyre Glass



**Azuria Reflective**  
#GL-xx-FR



**Black Reflective**  
#GL-xx-BR



**Bronze Reflective**  
#GL-xx-ZR



**Caribbean Blue Reflective**  
#GL-xx-NR



**Copper Reflective**  
#GL-xx-QR



**Emerald Reflective**  
#GL-xx-ER



**Gold Reflective**  
#GL-xx-HR



**Champagne Reflective**  
#GL-xx-CR

## Fyre Gems



**Black Granite**  
#GLG-xx-B



**Black Pearl**  
#GLG-xx-J



**Blue Topaz**  
#GLG-xx-T



**Champagne**  
#GLG-xx-D



**Deep Amber**  
#GLG-xx-A



**Emerald**  
#GLG-xx-E



**Glacier**  
#GLG-xx-C



**Sapphire**  
#GLG-xx-S



**Ruby**  
#GLG-xx-RY

## Diamond Nuggets



**Clear**  
#GLD-xx-C



**Steel Blue**  
#GLD-xx-SB



**Rosé**  
#GLD-xx-R



**Emerald**  
#GLD-xx-E



**Pacific Blue**  
#GLD-xx-PB



**Deep Black**  
#GLD-xx-DB



**Black Luster**  
#GLD-xx-BL

Due to the manufacturing process, glass color shade and density will vary.

# Gas Logs, Stones, & Lava Media



Shown: CHD-24

**Charred Oak (Vented)\***  
Model: **CHD-xx**



Shown: CHFR-24

**Charred Frontier Oak (Vent-Free)\***  
Model: **CHFR-xx**



**Back Country Oak**  
Model: **BCO-27**



**Desert Sage**  
Model: **DS-27**



Shown: G45-24-NA-SS

**G45 S.S. Vented Gas Log Burner\***

Model #	Description
<b>G45-xx-SS</b>	Match-Lit (NG only)
<b>G45-xx-N(P)A-SS</b>	w/ Assembled Valve

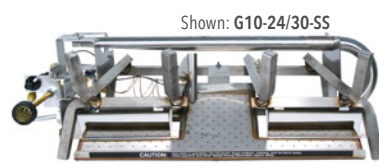

Shown: G10-24/30-SS

**G10 S.S. Vent-Free Gas Log Burner\***

Model #	Description
<b>G10-xx(P)-SS</b>	Manual
<b>G10-xx-12(P)-SS</b>	w/ ON/OFF Remote
<b>G10-xx-15(P)-SS</b>	w/ Variable Remote
<b>G10-xx-01V(P)-SS</b>	w/ Electronic Remote

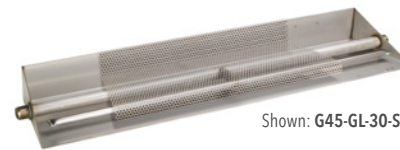

Shown: G45-GL-30-SS

**G45 S.S. Vented Glass Burner\***

Model #	Description
<b>G45-GL-xx-SS</b>	Match-Lit (NG only)
<b>G45-GL-xx-N(P)A-SS</b>	w/ Assembled Valve



Shown: G21-GL-24-12

**G21 Contemporary Vent-Free Burner\***

Model #	Description
<b>G21-GL-xx-12(P)</b>	w/ ON/OFF Remote
<b>G21-GL-xxG-12(P)</b>	w/ ON/OFF Remote & Gold Trim

*Accommodates Fyre Glass & Fyre Gems only.*

\*Gas log sets and Burner Kits are available in multiple sizes and are to be used **with Fireplaces only.**



**6" Spheres**  
Epic Black (FS6-4-EB)  
Graystone (FS6-4-GS)



**5" Spheres**  
Epic Black (FS5-4-EB)  
Graystone (FS5-4-GS)



**4" Spheres**  
Epic Black (FS4-4-EB)  
Graystone (FS4-4-GS)



**3" Spheres**  
Epic Black (FS3-4-EB)  
Graystone (FS3-4-GS)

**2" Spheres**  
Epic Black (FS2-4-EB)  
Graystone (FS2-4-GS)



**20-pc. Designer River Rock  
Fyre Stones**  
Model: **STN-20**



**10-pc. River Rock Fyre Stones**  
Model: **STN-10**



**Creekstones, Greige**  
20 lbs. (Approx. 140 pcs.)  
Model: **CSTN-20-G**



**Creekstones, Cloud**  
20 lbs. (Approx. 140 pcs.)  
Model: **CSTN-20-C**



**Creekstones, Mixed**  
20 lbs. (Approx. 140 pcs.)  
Model: **CSTN-20-CG**



**Creekstones, Black**  
20 lbs. (Approx. 140 pcs.)  
Model: **CSTN-20-B**



**Prairie Oak**  
Model: **PRO-27**



**Beachwood Logs w/ Stones**  
Model: **OCBW-34**



**Campfire Logs w/ Wood Chips**  
Model: **OCL-34**



**36-pc. Wood Chunks**  
Model: **WCD-36**



**Volcanic Stones**  
Model: **VS-25**



**Lava Coals**  
Model: **LFC-10**



**Lava Granules**  
Model: **LF-10**



**Charred Branches**  
Model: **BDC-4**



**Desert Sage Branches**  
Model: **BDS-2**

# Protective Covers

## Fabric Covers

Manufactured with a heavy duty, multi-layer PVC exterior, these covers are custom fit for selected Firetables, Fire Bowls, Fire Urns and the Nest Lantern. The black PVC material has been tested and proven for color-fastness.

### Additional Fabric Covers (not pictured)

Model:	Compatible with:
<b>8139A</b>	Contempo Rectangle Firetables
<b>8144A</b>	Milan Linear Firetable
<b>8146A</b>	Contempo Square Firetable
<b>8148A</b>	Bordeaux Rectangle Fire Bowl
<b>8149A</b>	Louvre Long Rectangle Fire Pit & Iron Saddle Firetable
<b>8150A</b>	Louvre Rectangle Fire Pit
<b>8151A</b>	Calais Oval Firetable
<b>5110-13-20</b>	5 gallon Propane Tank

## GFRC Covers

Manufactured out of the same Glass Fiber Reinforced Concrete (GFRC), these protective covers are designed to fit over the firetable opening protecting the burner assembly against wind and rain. They also provide additional table surface when the burner is not in use.

### Additional GFRC Covers (not pictured)

Model:	Compatible with:
<b>8105-xx</b>	Contempo Round Firetable
<b>8108-xx</b>	Piaget Fire Urn
<b>8123-xx</b>	Cosmo Square Dining Firetable
<b>8125-xx</b>	Contempo Square Firetable

## Fabric Covers



### 48" Round Firetable Cover

Model: **8135A**

#### Compatible with:

- Amphora Firetable
- Inverted Firetable
- Cosmopolitan Round Firetable
- 48" Fire Bowl



### 54"/60" Round Firetable Cover

Model: **8131A**

#### Compatible with:

- Fiesta Firetables
- Versailles Firetable



### 36" Square Firetable Cover

Model: **8132A**

#### Compatible with:

- Cosmopolitan Square Firetable
- Voro Firetable
- Bordeaux Square Fire Bowls



### Rectangular Firetable Covers

Model shown: **8138A**

#### Compatible with:

- Cosmopolitan Rectangle Firetable



### Fire Urn Cover

Model: **8141A**

#### Compatible with:

- Piaget Fire Urn
- Eclipse Fire Urn
- Wave Fire Urn



### Lantern Cover

Model: **8134A**

#### Compatible with:

- Nest Lantern
- Magnolia Lantern

## Fabric Covers



### 60" Square Firetable Cover

Model: **8137A**

#### Compatible with:

- Cosmopolitan Square Dining Firetables



### 40" Fire Bowl/Fire Pit Cover

Model: **8140A**

#### Compatible with:

- 36" Fire Bowl
- 40" Marseille Fire Bowl
- Chiseled Fire Pit
- El Dorado Fire Pit
- Contractor's Mdl. Fire Pit



### 48" Round Firetable/Bowl Cover

Model: **8143A**

#### Compatible with:

- Contempo Round Firetable
- Lotus Firetable
- 48" Marseille Fire Bowl
- Louvre Round Fire Pit



### 32" Fire Bowl Cover

Model: **8142A**

#### Compatible with:

- 32" Fire Bowl
- 32" Marseille Fire Bowl

## GFRC Covers



### Reclaimed Wood GFRC Covers

Model shown: **8120-FO**

Model:	Compatible with:
<b>8100-FO (-SP)</b>	<ul style="list-style-type: none"> <li>• Cosmo Round Firetable</li> <li>• Contempo Round Firetable</li> </ul>
<b>8110-FO (-SP)</b>	<ul style="list-style-type: none"> <li>• Cosmo Rectangle Firetable</li> <li>• Contempo Rect. Firetable</li> </ul>
<b>8120-FO (-SP)</b>	<ul style="list-style-type: none"> <li>• Cosmo Square Firetable</li> <li>• Contempo Square Firetable</li> </ul>
<b>8123-FO (-SP)</b>	<ul style="list-style-type: none"> <li>• Cosmo Sq. Dining Firetable</li> </ul>

Reclaimed Wood Finishes:

French Barrel Oak (**FO**) and Silver Pine (**SP**)

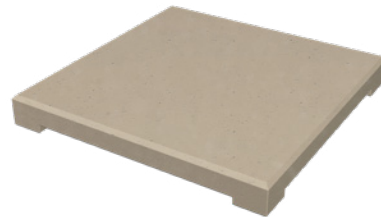

### Square GFRC Covers

Model shown: **8120-SM**

#### Compatible with:

- Cosmo Square Firetable
- Voro Firetable
- Contempo Square Firetable



### Round GFRC Cover

Model shown: **8100-CB**

#### Compatible with:

- Fiesta Firetables
- Inverted Firetable
- Amphora Firetable
- Cosmopolitan Round Firetable

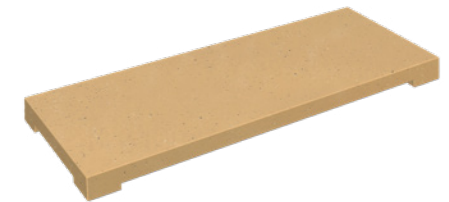

### Rectangular GFRC Cover

Model shown: **8110-CB**

#### Compatible with:

- Cosmopolitan Rectangle Firetable
- Contempo Rectangle Firetable

Photographs of the protective covers shown are not to scale or in proportion.

# Fireplace Accessories



*Pictured above: Black Scroll Screen (8255-BL) on Grand Cordova Fireplace (882-35-H-CB-xxC) with 24" Charred Majestic Oak (CHMJ-24) log set.*



# Fireplace Accessories

Complement your fireplace with optional accessories custom made for each fireplace model. From Chimney Rain Vent Caps to Mesh Screens featuring Wrought Iron Scroll accents as well as GFRP Protector Plates, each accessory is expertly crafted with the same attention to detail and care as our fireplaces.

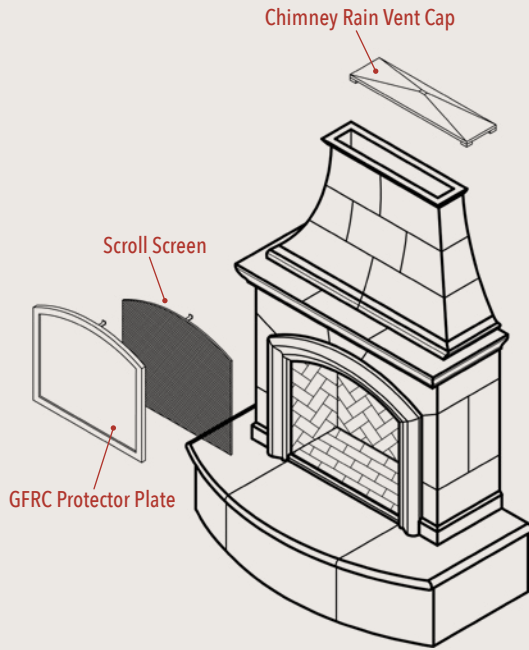

**GFRP Protector Plate**

Model shown: **8210-CB**

**Compatible with:**

- Cordova
- Reduced Cordova
- Grand Cordova



**GFRP Protector Plate**

Model shown: **8205-CB**

**Compatible with:**

- Petite Cordova
- Grand Petite Cordova



**GFRP Protector Plate**

Model shown: **8200-CB**

**Compatible with:**

- Phoenix
- Grand Phoenix
- Mariposa
- Grand Mariposa

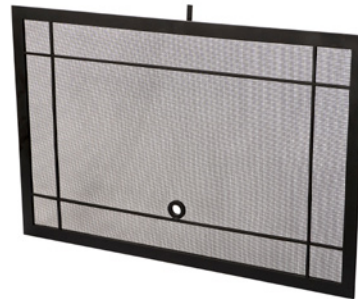

**Brooklyn Mesh Screen**

Model shown: **8256-BL**

**Compatible with:**

- Brooklyn

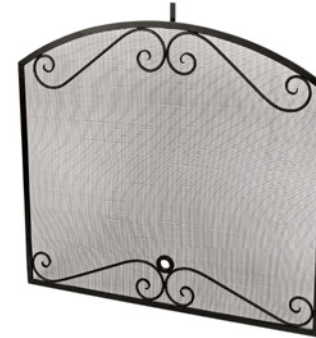

**Arched Black Scroll Screen**

Model shown: **8250-BL**

**Compatible with:**

- Phoenix
- Grand Phoenix
- Mariposa
- Grand Mariposa



**Black Scroll Screen**

Model shown: **8255-BL**

Model: **8255-BL**

**Compatible with:**

- Cordova
- Reduced Cordova
- Grand Cordova

Model: **8253-BL**

**Compatible with:**

- Petite Cordova
- Grand Petite Cordova



**Brooklyn Rain Vent Cap**

Model shown: **8050RV-SM**

**Compatible with:**

- Brooklyn



**Chimney Rain Vent Cap**

Model shown: **8023RV-CB**

**Multiple models available to fit most American Fyre Designs™ fireplaces.**

# Glass Wind Guards, Tank/End Tables, & Extension Hose



## Square Glass Wind Guard

Model: **8202-WG**

### Compatible with:

- Cosmopolitan Square Firetable
- Voro Firetable
- Voro Cube
- Contempo Square Firetable



## Square Glass Wind Guard

Model: **8210-WG**

### Compatible with:

- Cosmo Square Dining Firetable



## Round Glass Wind Guard

Model: **8208-WG**

### Compatible with:

- Amphora Firetable
- Inverted Firetable
- Fiesta Firetable
- Contempo Round Firetable
- Cosmopolitan Round Firetable
- Lotus Firetable



## Rectangular Glass Wind Guards

Model shown: **8204-WG**

Model: **8204-WG**

### Compatible with:

- Contempo Rectangle Firetable
- Cosmopolitan Rectangle Firetable

Model: **8211-WG**

Compatible with Iron Saddle Firetable

Model: **8212-WG**

Compatible with Milan Firetables



## Recl. Wood Contempo Tank/End Table

Model shown: **8510-BA-FO**

- Dimensions: 20 $\frac{3}{4}$ " dia. x 19 $\frac{1}{4}$ " h
- Top shown: FO, French Barrel Oak



## Contempo Tank/End Table

Model shown: **8510-CB**

- Dimensions: 20 $\frac{3}{4}$ " dia. x 19 $\frac{1}{4}$ " h
- Finish shown: CB, Café Blanco



## 10 ft. Propane Extension Hose

Model: **5110-26**

- Compatible with all L.P. units



Note: Top also available in Silver Pine (SP) finish (model #: **8510-BA-SP**); base in Black Lava (BA) finish only.

## Finish Colors

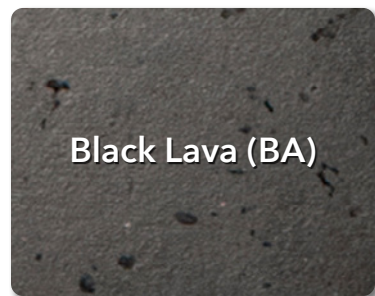
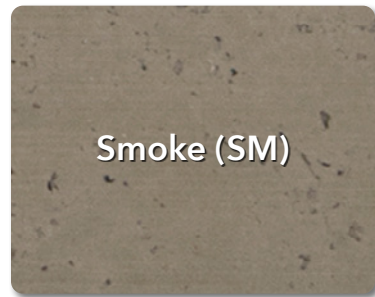
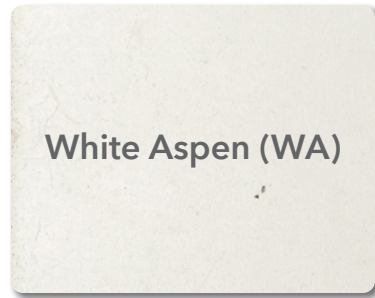

## Antique Finishes



## Table Top Options



PRODUCT DESCRIPTION	FINISH COLORS	ANTIQUE FINISHES	TABLE TOP/MANTEL OPTIONS	
			FRENCH BARREL OAK	SILVER PINE
<b>FIREPLACES</b>				
Cordova	●			
Reduced Cordova	●			
Petite Cordova	●			
Grand Cordova	●			
Grand Petite Cordova	●			
Phoenix	●			
Grand Phoenix	●			
Mariposa	●			
Grand Mariposa	●			
Manhattan	●			
Brooklyn	Concrete Grey		● (Mantel)	● (Mantel)
Brooklyn Smooth	Grey		● (Mantel)	● (Mantel)
Contractor's Model	White Concrete			
Contractor's Model w/ Moulding	Concrete			
<b>FIRETABLES</b>				
Amphora	●	●		
Calais Oval	●	●		
Contempo*	●	●	●	●
Contempo LP Select *	●	●	●	●
Cosmopolitan*	●	●	●	●
Fiesta	●	●		
Inverted	●	●		
Iron Saddle	●	●		
Lotus	●	●		
Milan Linear	●	●		
Versailles	●	●		
Voro	●	●		
<b>FIRE BOWLS</b>				
Fire Bowls	●	●		
Marseille	●	●		
Bordeaux	●	●		
Reclaimed Wood Bordeaux			●	●
<b>FIRE PITS</b>				
Chiseled	●	●		
El Dorado	●	●		
Contractor's Model	●	●		
Louvre	●	●		
<b>FIRE URNS &amp; LANTERN</b>				
Piaget Fire Urn & Pedestal	●	●		
Eclipse	●	●		
Wave	●	●		
Nest Lantern	●	●		
Magnolia Lantern	●	●		

\*Bases on Reclaimed Wood Firetables are available in Black Lava (BA) finish only.

Note: American Fyre Designs™ products are individually handcrafted and finishes shown are subject to slight texture and color variation.

## **AMERICAN FYRE DESIGNS™ LIMITED WARRANTY HIGHLIGHTS**

### **THREE (3) YEAR WARRANTY**

AMERICAN FYRE DESIGNS™ EXTERIOR (GFRC) FIRE FEATURES AND ACCESSORIES ARE WARRANTED FOR **THREE (3) YEARS**

### **ONE (1) YEAR WARRANTY**

ALL AMERICAN FYRE DESIGNS™ VALVES, BURNERS, ELECTRICAL COMPONENTS, AND CONTROLS (EXCLUDING BATTERIES) ARE WARRANTED FOR **ONE (1) YEAR**

*THIS WARRANTY APPLIES TO THE ORIGINAL PURCHASER WITH INVOICE OR PROOF OF PURCHASE AND TO SINGLE FAMILY RESIDENTIAL USE ONLY. FOR ADDITIONAL INFORMATION REGARDING THIS WARRANTY, OR TO PLACE A WARRANTY CLAIM CONTACT YOUR AUTHORIZED AMERICAN FYRE DESIGNS™ DEALER*

*Diagrams, illustrations and photographs are not to scale – consult installation instructions.*

*Product designs, materials, dimensions, specifications, colors and prices are subject to change or discontinuance without notice.*



---

14724 Proctor Ave • City of Industry, CA 91746

Phone (626) 369-5085 • Fax (626) 369-5979

[www.americanfyredesigns.com](http://www.americanfyredesigns.com)