

# Fire Garden™

## Outdoor Linear Complete Fire Pit

### Manual

48x24 Complete Fire Pit	94900432
72x24 Complete Fire Pit	94900449
108x24 Complete Fire Pit	94900461



Listed by  
Omni-Test Laboratories, Inc.  
**Report # 0028GM127S**  
ANSI Z21.97-2017 / CSA 2.41-2017, CSA 2.17-2017  
Outdoor Decorative Gas Appliances

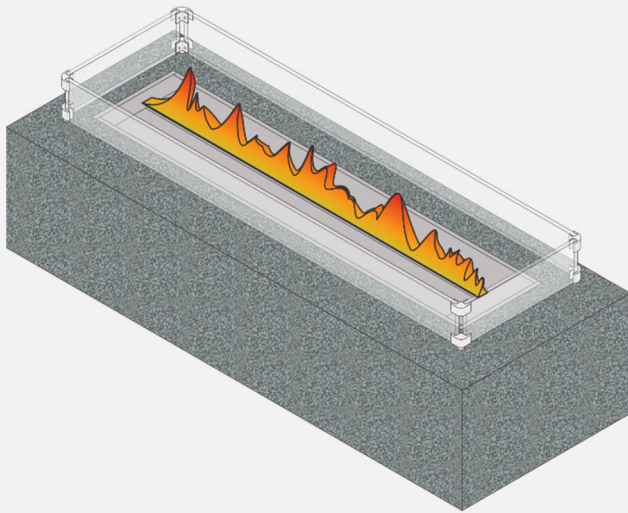

**⚠ DANGER**  
**FIRE OR EXPLOSION HAZARD**  
If you smell gas:

- Shut off gas to the appliance.
  - Extinguish any open flame.
  - If odor continues, leave the area immediately.
  - After leaving the area, call your gas supplier or fire department.
- Failure to follow these instructions could result in fire or explosion, which could cause property damage, personal injury, or death.

**⚠ WARNING**

Do not store or use gasoline or other flammable vapors and liquids in the vicinity of this or any other appliance. An LP cylinder not connected for use shall not be stored in the vicinity of this or any other appliance.

**⚠ WARNING:** For outdoor use only. Installation and service must be performed by a qualified installer, service agency, or the gas supplier.

**⚠ WARNING:** Improper installation, adjustment, alteration, service or maintenance can cause injury or property damage. Read the installation, operating, and maintenance instructions thoroughly before installing or servicing this equipment.

**⚠ WARNING:** If the information in this manual is not followed exactly, a fire or explosion may result causing property damage, personal injury, or loss of life.

**INSTALLER:** Leave this manual with the appliance.  
**CONSUMER:** Retain this manual for future reference

**⚠ DANGER**



### CARBON MONOXIDE HAZARD

This appliance can produce carbon monoxide which has no odor.

Using it in an enclosed space can kill you.

Never use this appliance in an enclosed space such as a camper, tent, car, or home.

French language manuals at [outdoorfiregarden.com](http://outdoorfiregarden.com). Manuels de langue Française à [outdoorfiregarden.com](http://outdoorfiregarden.com)

## Overview

This manual details the installation, operation, and routine maintenance of the Outdoor Linear Fire Pit.

## Listing Details

This appliance was tested to ANSI Z21.97-2017 / CSA 2.41-2017 “Outdoor Decorative Gas Appliances”, CSA 2.17-2017 - “Gas-Fired Appliances for Use at High Altitudes”. The listing label is chained to the appliance. A copy is shown to the right.

## Important Registration & Service Info

No other appliance has the same serial number as yours. The serial number is on the safety label attached by a chain under the media screen. This serial number will be needed in case you require service of any type. To receive full warranty coverage, you will need to show evidence of the date of purchase. Visit [traviswarranty.com](http://traviswarranty.com) to register your appliance. If any service issues arise, contact your dealer for assistance.

## National Fireplace Institute



**NATIONAL FIREPLACE INSTITUTE**  
**CERTIFIED**  
[www.nficertified.org](http://www.nficertified.org)

We suggest that our gas hearth products be installed and serviced by professionals who are certified in the U.S. by the National Fireplace Institute® (NFI) as NFI Gas Specialists.

## Dealer Information

Please record your dealer information here for future reference:

Dealer Name: \_\_\_\_\_  
 Dealer Address: \_\_\_\_\_  
 Dealer E-Mail: \_\_\_\_\_  
 Dealer Phone #: \_\_\_\_\_

**CALIFORNIA RESIDENTS**



**WARNING:** This product can expose you to chemicals including Carbon Monoxide and Benzene, which are known to the State of California to cause cancer, birth defects, or other reproductive harm. For more information go to [www.P65Warnings.ca.gov](http://www.P65Warnings.ca.gov).

Serial Number



	NG	LP
Input Rating (BTU/h)	7" wc	11" wc
Orifice Size	7" wc	11" wc
Manifold Pressure	6" wc	10" wc
Max. Inlet Pressure		
Min. Inlet Pressure		

**GAS RATING**  
 Input Rating (BTU/h)  
 Orifice Size  
 Manifold Pressure  
 Max. Inlet Pressure  
 Min. Inlet Pressure

Tested to: ANSI Z21.97-2017 / CSA 2.41-2017 “Outdoor Decorative Gas Fireplace”, “CSA 2.17-2017 - “Gas-Fired Appliances for Use at High Altitudes”, Suitable for use in elevations of 0-4500 ft (0-1370 m). Electrical Rating: 120 VAC., 60 Hz, 0.9 Amps (Electrical rating for the basic model only: 24 VAC., 60 Hz, 1.6 Amps.)

For outdoor installation only. The gas supply must be turned off at the LP-gas supply cylinder when this appliance is not in use (if applicable). Cover must be removed when burner is in operation.

**MANUFACTURE DATE:**

<input type="checkbox"/>	2022	<input type="checkbox"/>	Jan.	<input type="checkbox"/>	Apr.	<input type="checkbox"/>	Jul.	<input type="checkbox"/>	Oct.
<input type="checkbox"/>	2023	<input type="checkbox"/>	Feb.	<input type="checkbox"/>	May	<input type="checkbox"/>	Aug.	<input type="checkbox"/>	Nov.
<input type="checkbox"/>	2024	<input type="checkbox"/>	Mar.	<input type="checkbox"/>	Jun.	<input type="checkbox"/>	Sep.	<input type="checkbox"/>	Dec.

Min. Clearances to Combustible Materials\*

\*See manual for further details

Overview.....	2	Direct-Run Wire Length Chart.....	24
Listing Details.....	2	Wiring Examples:.....	24
Important Registration & Service Info.....	2	Daisy-Chain Installations:.....	24
Safety Precautions.....	4	Direct Run Installations:.....	24
Features:.....	5	Steps for Finalizing the Installation.....	25
Installation Options:.....	5	Crushed Glass Installation.....	25
Electrical Specifications:.....	5	Rock Ember Installation.....	26
Appliance Weight:.....	5	Tumbled Stone Installation.....	27
Gas Specifications:.....	5	Assembling the Glass Wind Guard.....	28
Linear Fire Pit Dimensions:.....	6	Assembling the Glass Wind Guard (48" & 72" units)....	28
Installation Warnings:.....	7	Assembling the Glass Wind Guard (108" units).....	29
Recommended Order of Installation.....	8	Before the First Fire.....	32
Packing List.....	8	Operating Instructions.....	32
Additional Items Required.....	9	Location of Controls.....	33
Weatherproofing the Installation.....	10	Maintaining Your Appliance.....	34
Appliance Placement Requirements.....	10	Accessing Components.....	35
Clearances.....	11	Removing the Media Trays.....	35
Enclosure Ventilation Requirements.....	12	Accessing the Pressure Tap.....	36
Gas Line Requirements.....	13	Removing the Burner.....	36
LP Conversion.....	14	Accessing Pilot Components.....	36
Electrical Connection Requirements.....	15	Winterizing the Appliance.....	37
24VAC Transformer.....	15	Yearly Service Procedure.....	37
Installation Details.....	16	Replacement Parts List.....	38
Using More than One 24-volt Appliance.....	21	Troubleshooting Table.....	39
Wiring Multiple Transformers to One Switch.....	21	Wiring Diagram.....	41
Wiring Multiple Appliances to One Transformer.....	22	Index.....	44
Daisy-Chain Example.....	22		
Direct-Run Example.....	22		
Daisy-Chain Wire Length Chart.....	23		

**! This appliance must be installed in accordance with all local codes if any; if not, follow ANSI Z223.1.**

**! This appliance must only be used outdoors in a well-ventilated area. It may not be used in a building, garage, or other enclosed space.**

- This appliance is not for use with solid fuel.
- The appliance must be kept clean and free of leaves and debris to ensure safe operation.
- Any hose or gas supply line that is damaged or shows evidence of excessive abrasion or wear must be replaced prior to use of the appliance.
- If using a gas supply line to the appliance, make sure it is properly located away from any walkway or in an area where it may be subject to accidental damage.
- Educate all children and adults about the dangers of the appliance. Young children should be supervised when they are in the same area as the appliance. Do not let children play with the appliance.
- Do not place clothing or other flammable items on or near the appliance.
- Any screen or guard removed for servicing must be replaced prior to operating the appliance.
- This unit must be installed and repaired by a qualified installer to prevent the possibility of an explosion. Your dealer will know the requirements in your area and can inform you of those people considered qualified. The appliance should be inspected before use and at least annually by a qualified service person. More frequent cleaning may be required due to excessive debris from leaves, dirt, insects, etc.
- Do not use this appliance if any part has been underwater. Immediately call a qualified service technician to inspect the appliance and replace any part of the control system and any gas control that has been underwater.
- The instructions in this manual must be strictly adhered to. Do not use makeshift methods or compromise in the installation. Improper installation will void the warranty and safety listing.
- This appliance is approved for either natural gas (NG) or propane (LP). Burning the incorrect fuel will void the warranty and safety listing and may cause an extreme safety hazard. Direct questions about the type of fuel used to your dealer. A label is placed on the control panel to show which fuel the appliance is designed for.
- Contact your local building officials to obtain a permit and information on any installation restrictions or inspection requirements in your area.
- If the flame becomes sooty, dark orange in color, or extremely tall, do not operate the appliance. Call your dealer and arrange for proper servicing.
- Do not operate the appliance if it is not operating properly in any fashion or if you are uncertain. Call your dealer for a full explanation of your appliance and what to expect.
- Do not store or use gasoline or other flammable liquids in the vicinity of this appliance.
- Never remove, replace, modify, or substitute any part of the appliance unless instructions are given in this manual for routine maintenance and cleaning. A trained technician must do all other work. Do not modify or replace orifices.
- Allow the appliance to cool before carrying out any maintenance or cleaning.
- Operate the appliance according to the instructions included in this manual.
- If the burner does not start correctly turn the gas off at the gas control valve and call your dealer for service.
- Do not use this appliance to cook food.
- Instruct everyone in the house on how to shut the gas off to the appliance and at the gas main shutoff valve. The gas main shutoff valve is usually next to the gas meter or propane tank and requires a wrench to shut off.
- Do not operate the appliance during a lightning storm or a possible lightning storm.
- Do not operate the appliance during high wind conditions.
- Do not install in or on recreational vehicles and/or boats.
- Do not throw this manual away. This manual has important operating and maintenance instructions that you will need at a later time. Always follow the instructions in this manual.
- **Travis Industries, Inc. grants no warranty, implied or stated, for the installation or maintenance of your appliance, and assumes no responsibility for any consequential damage(s).**

## Features:

- Electronic Ignition (switch turns appliance on or off)
- Tempered glass wind guard
- Stainless Steel Construction
- Automatic Gas Shutoff Valve for Safety

## Installation Options:

- For Outdoor Installation Only
- For Fixed Gas Line Installations Only

## Electrical Specifications:

24 VAC., 60 Hz, 1.6 Amps.

## Appliance Weight:

<b>48x24 Complete Fire Pit</b>	125 lbs (56.7 kg)
<b>72x24 Complete Fire Pit</b>	175 lbs (79.4 kg)
<b>108x24 Complete Fire Pit</b>	260 lbs (117.9 kg)

## Gas Specifications:

<b>All Fire Pits</b>	<b>Gas Pressures</b>	<b>NG</b>	<b>LP</b>
	Manifold Pressure	7" wc	11" wc
	Max. Inlet Pressure	7" wc	11" wc
	Min. Inlet Pressure	6" wc	10" wc

<b>48x24 Fire Pit</b>	<b>Input Rating</b>	<b>NG</b>	<b>LP</b>
	Input Rating (BTU/h)	65,000	65,000
	Orifice Size (DMS)	(1) - #29	(1) - #41

<b>72x24 Fire Pit</b>	<b>Input Rating</b>	<b>NG</b>	<b>LP</b>
	Input Rating (BTU/h)	120,000	120,000
	Orifice Size (DMS)	(2) - #30	(2) - #43

<b>108x24 Fire Pit</b>	<b>Input Rating</b>	<b>NG</b>	<b>LP</b>
	Input Rating (BTU/h)	185,000	185,000
	Orifice Size (DMS)	(2) - #30 (1) - #41	(2) - #43 (1) - #41

## Linear Fire Pit Dimensions:

48x24 Fire Pit

**Windbreak Glass**

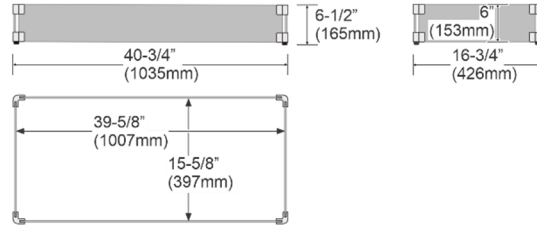

**Linear Burner**

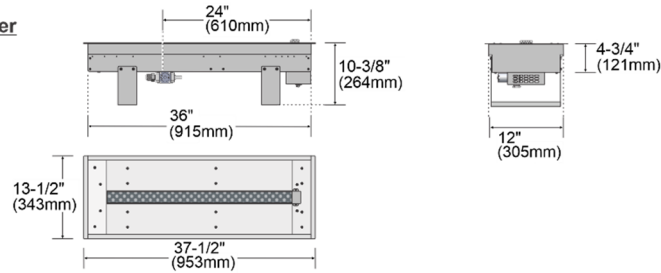

**Enclosure**

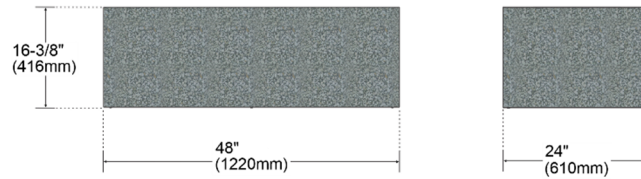

**Windbreak Glass**

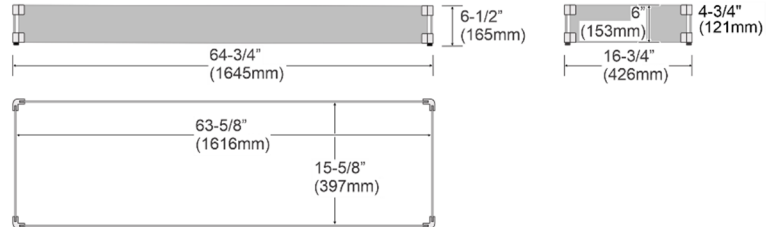

**Linear Burner**

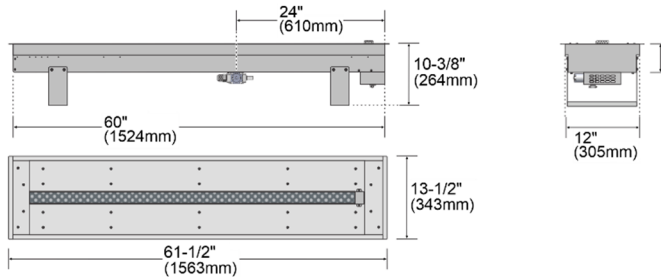

**Enclosure**

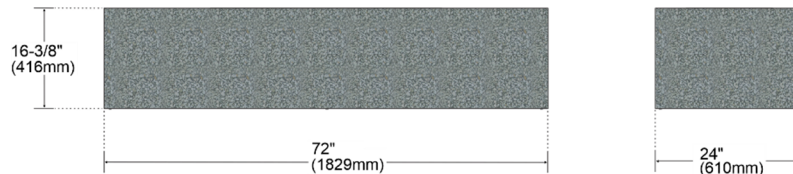

72x24 Fire Pit

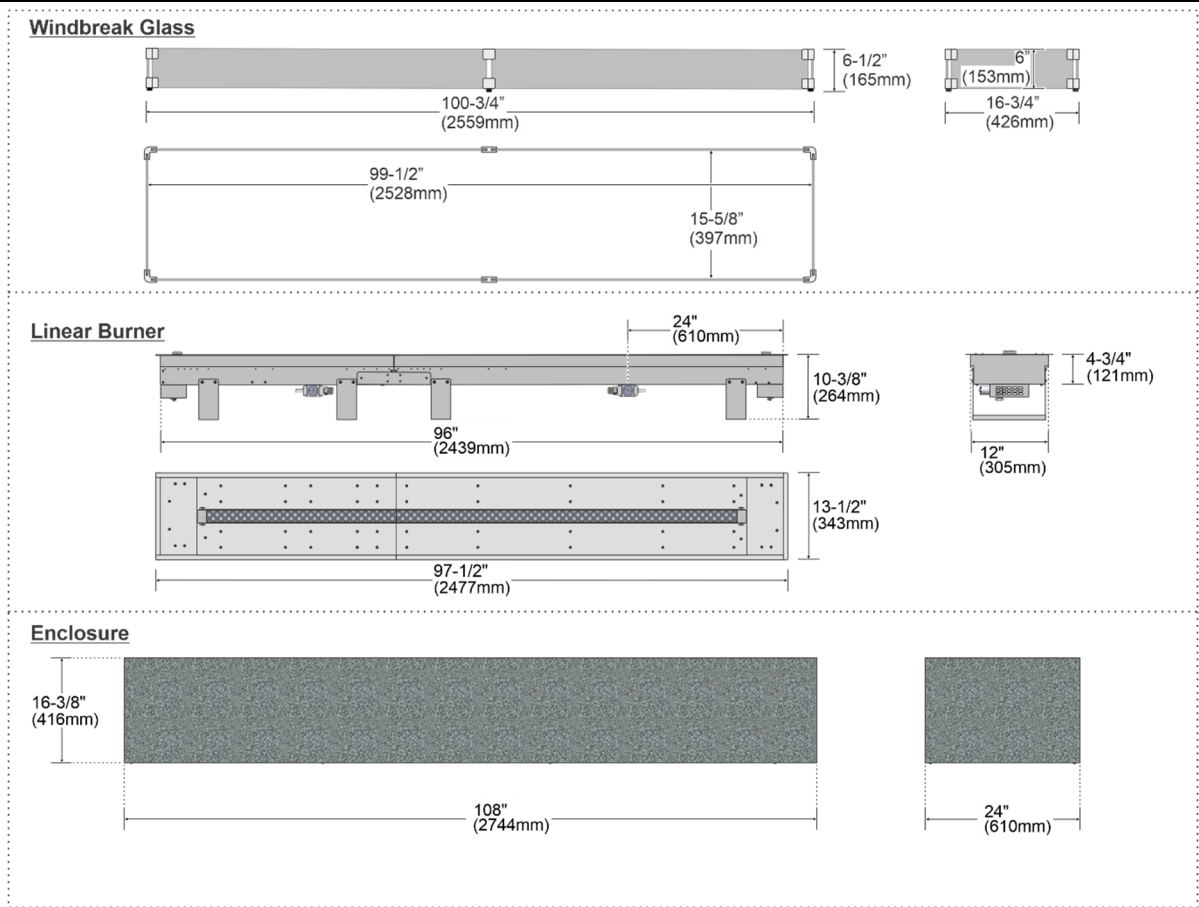

## Installation Warnings:

- ! This appliance is designed for outdoor use only, in well-ventilated areas.
- ! Failure to follow all the requirements may result in property damage, bodily injury, or even death.
- ! This appliance must be installed by a qualified installer.
- ! This appliance is designed to operate on natural gas, or propane (LP).
- ! This appliance requires a switched, 110v AC, GFCI (ground-fault circuit interrupter) protected power supply. This circuit provides power to the 24v AC transformer.
- ! Notify your insurance company before hooking up this appliance. All relevant information on the appliance is located on page 2, *Important Information*. You provide them page 2.
- ! The requirements listed below are divided into sections. All requirements must be met simultaneously. The order of installation is not rigid – the qualified installer should follow the procedure best suited for the installation.

***Recommended Order of Installation***

---

1. **CAREFULLY PLAN THE INSTALLATION.** Determine the location of the Linear Fire Pit and the controls. Make sure all clearances are met, (see page 11).

2. Supply Gas: The appliance requires:

- 65,000 BTU input (natural gas or LP) for a 48x24 Fire Pit
- 120,000 BTU input (natural gas or LP) for a 72x24 Fire Pit
- 185,000 BTU input (natural gas or LP) for the 108x24 Fire Pit

A 3/4-inch flex line and 3/4" MPT (male pipe thread) x flare fitting adapter are provided to assist connection from the supply line to the appliance valve. Before turning the gas on to the appliance, leak-test all gas line connections. Convert the appliance to LP gas if applicable.

3. Supply Electrical: The appliance uses 24VAC power and draws approximately 1.6 amps - Make sure the circuit and wiring are appropriately sized (see diagrams starting on pg. 21.). If multiple appliances are powered through a single switch the control modules for each of the individual appliances may be daisy-chained together. Make sure to leave slack in the electrical line so the appliance or linear burner tray can be removed for service.
4. Bleed the gas line and start the appliance by switching on the electrical power to the control module. Leak test the gas lines. Verify the appliance works correctly and there are no gas leaks.
5. Finalize the installation. Install the enclosure facing, glass wind guard, and crushed glass or stone media.
6. Give the manual to the homeowner and explain the operation of the appliance.

***Packing List***

---

- Glass Wind Guard, mounting brackets, and set screws.
  - 48" & 72" Pit - (2) ends and (2) sides
  - 108" Pit – (2) ends, (2) sides with logos, and (2) sides without logos
- LP Conversion Kit - see "LP Conversion" on page 14 for details.
- Wall Switch and wall switch cover.
- 3" gas shutoff key.



## Additional Items Required

- Gas Line Equipment.
- 24volt transformer – (sku# 94800830)
- Low voltage wire (from transformer to appliance)
- High voltage wire (from house circuit to transformer)
- Weatherproof enclosure for wall switch (only needed if the switch is to be installed outdoors).
- Media (Crushed Glass, Ember Rock, or Tumbled Stones)

### Travis Industries offers the following Crushed Glass Options:

- Platinum sku# 94500580
- Cobalt sku# 94500582
- Bronze sku# 94500581
- Black sku# 94500583

**NOTE:** The part numbers above are for 10 lbs. of crushed glass so make sure to order the appropriate number of boxes of the desired part number (see chart below).

Appliance	Amount of Media needed	# of boxes needed
48x24 Fire Pit	15 lbs. (6.8kg)	2
72x24 Fire Pit	25 lbs. (11.34kg)	3
108x24 Fire Pit	35 lbs. (15.9kg)	4

### Travis Industries offers the following Ember Rock Option:

- Rock Embers - Small sku# 94500987
- Rock Embers - Large sku# 94500988

**NOTE:** The part numbers above provide 10lb bags of media for each size respectively. Make sure to order the appropriate number of boxes for the appliance (see chart below).

Appliance	Amount of Media needed	# of 94500987 needed	# of 94500988 needed
48x24 Fire Pit	5 lbs. (2.27 kg) small & 10 lbs. large (4.54 kg)	1	1
72x24 Fire Pit	10 lbs. (4.54 kg) small & 20 lbs. large (9.07 kg)	1	2
108x24 Fire Pit	15 lbs. (6.8 kg) small & 30 lbs. large (13.6 kg)	2	3

### Travis Industries offers the following Stone Option:

- Tumbled Stone - Small sku# 94500985
- Tumbled Stone - Large sku# 94500986

**NOTE:** The part numbers above provide 10 lbs. of small and 20 lbs. of large Tumbled Stone respectively. Make sure to order the appropriate number of boxes for the appliance (see chart below).

Appliance	Amount of Media needed	# of 94500985 needed	# of 94500986 needed
48x24 Fire Pit	30 lbs. (13.61 kg) small & 20 lbs. large (9.07 kg)	3	1
72x24 Fire Pit	50 lbs. (22.68 kg) small & 20 lbs. large (9.07 kg)	5	1
108x24 Fire Pit	80 lbs. (36.29 kg) small & 40 lbs. large (18.14 kg)	8	2

***Weatherproofing the Installation***

This appliance is designed to withstand being installed outdoors in the elements; however, the enclosure will need to be designed and constructed to withstand the same. The builder must provide a means for water to escape the enclosure that is appropriate and specific to the site of the installation. This may necessitate improving ground drainage, the fabrication of a drain pan, the creation of weep holes in the base of the enclosure, or building a roof over the appliance (covers over the appliance must meet all the requirements detailed in this manual).

***Appliance Placement Requirements***

**! For Outdoor Use Only. Install in well-ventilated areas.**

**! WARNING !**

**The appliance is considered to be “outdoors” if installed with shelter no more inclusive than:**

- Walls on all sides, but with no overhead cover.
- Within a partial enclosure that includes an overhead cover and no more than two sidewalls. The sidewalls may be parallel, as in a breezeway, or at right angles to each other.
- Within a partial enclosure that includes an overhead cover and three sidewalls, as long as 30 percent or more of the horizontal periphery of the enclosure is permanently open.

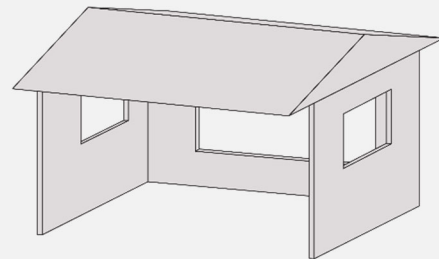
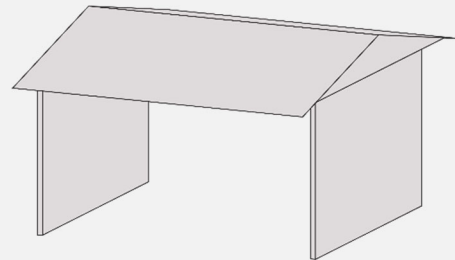
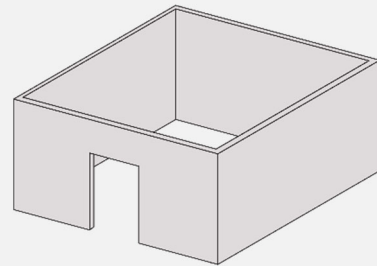

- The appliance must be installed on a level surface capable of supporting the appliance's weight.
- The appliance must be placed directly on wood or non-combustible surface.
- The appliance should be located out of traffic and away from furniture and draperies.
- The distance from the top of the burner to a ceiling above the appliance must be a minimum of 65" (1651mm) for a 48x24 or 72x24 appliance, or 75" (1905mm) for a 108x24 appliance.

**Do Not Locate the Appliance:**

- In high traffic areas.
- Under or near trees, plants, and buildings where debris may constantly fall into the appliance. Excessive debris will require high maintenance and/or cause malfunctioning of the appliance.
- In places where people, children, and pets may contact the appliance. Guards or fences around the appliance in these locations are recommended.
- In places where the controls beneath the appliance may be submerged underwater. Submerging any part of its controls may require the complete replacement of the controls.

## Clearances

### 48x24 & 72x24 Fire Pits ONLY

**Linear Fire Pits**  
48x24 Fire Pit  
72x24 Fire Pit

**NO COMBUSTIBLES  
ALLOWED IN THE  
SHADED AREA**

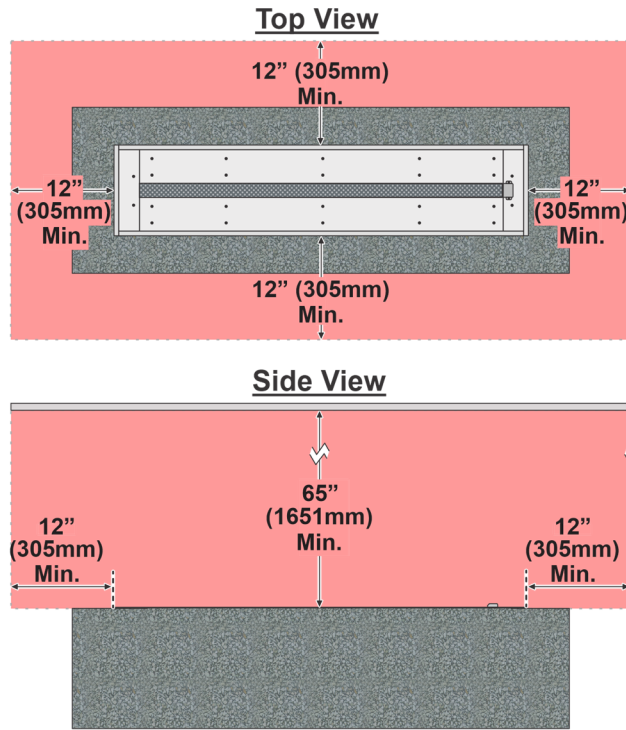

### 108x24 Fire Pit ONLY

**Linear Fire Pits**  
108x24 Fire Pit

**NO COMBUSTIBLES  
ALLOWED IN THE  
SHADED AREA**

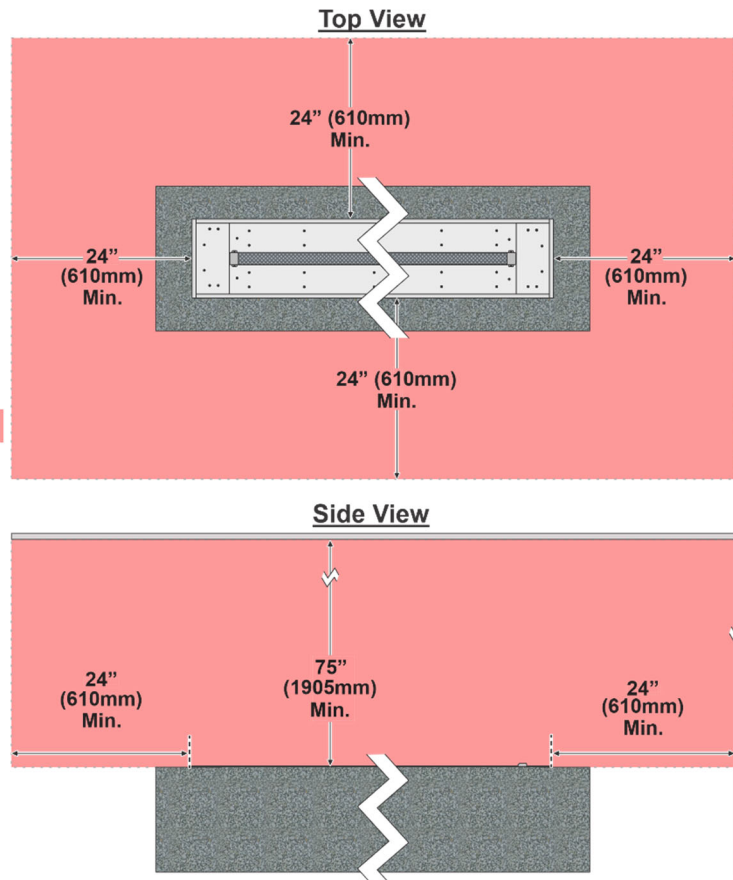

## Enclosure Ventilation Requirements

The fire pit enclosure must be ventilated to properly cool the fire pit (see illustration below for details).



**WARNING**



The enclosure must be ventilated in accordance with the requirements listed below to allow the appliance to cool. Failure to provide this ventilation will create a severe fire risk.

### Enclosure Ventilation Overview

- The fire pit enclosure rests on adjustable leveling legs that provide a minimum 1/2" gap on the bottom of the enclosure. This 1/2" minimum gap must be maintained to provide cooling air to the appliance components. Failure to maintain the gap will create a severe fire risk and will void the appliance warranty.
- The height of the leveling legs can be adjusted by turning the leveling leg foot. The legs will adjust from 1/2" to 1"

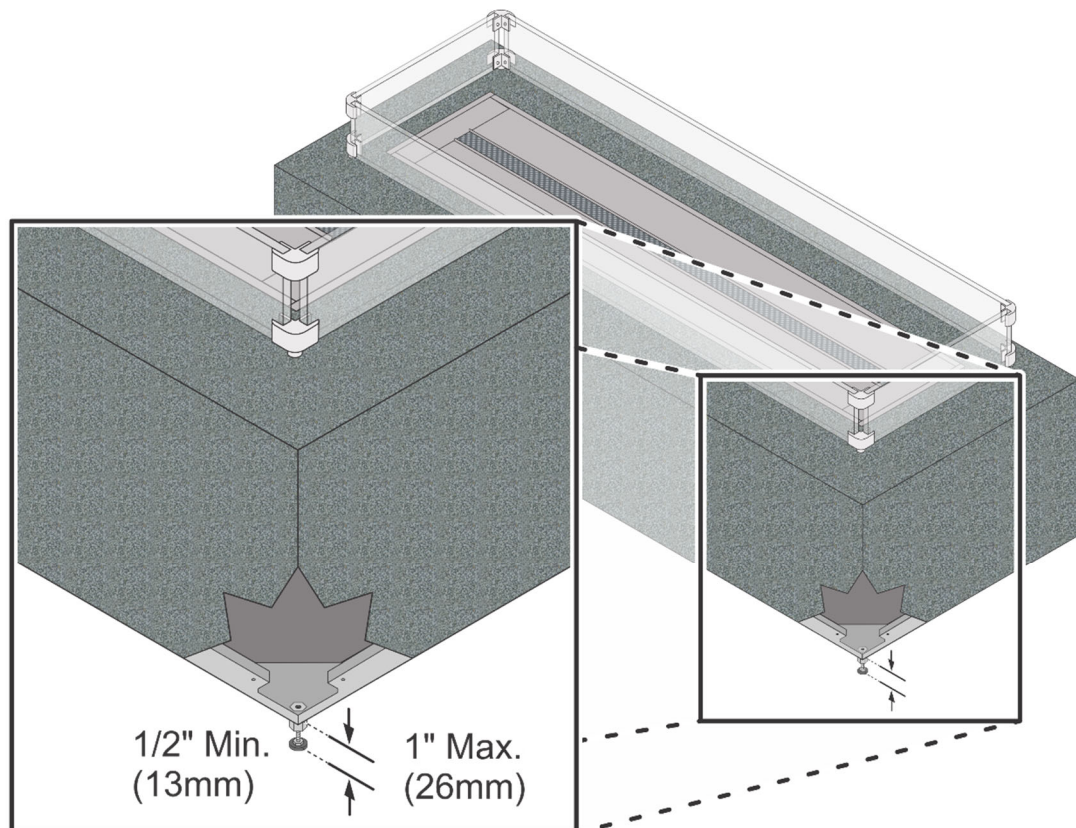

## Gas Line Requirements

### MASSACHUSETTS INSTALLATIONS - WARNING:

THIS PRODUCT MUST BE INSTALLED BY A LICENSED PLUMBER OR GAS FITTER WHEN INSTALLED WITHIN THE COMMONWEALTH OF MASSACHUSETTS.

OTHER MASSACHUSETTS CODE REQUIREMENTS:

- Flexible connector must not be longer than 36 inches.
- Shutoff must be a "T" handle gas cock.
- Only direct vent sealed combustion products are approved for bedrooms or bathrooms.
- Fireplace dampers must be removed or welded in the open position prior to the installation of a fireplace insert or gas log.
- A carbon monoxide (CO) detector is required in the same room as the appliance.

- ! The gas line must be installed in accordance with all local codes or, in the absence of local codes, with the National Fuel Gas Code, ANSI Z223.1/NFPA 54, International Fuel Gas Code, Natural Gas, and Propane Installation Code, CSA B149.1, or Propane Storage and Handling Code, B149.2, as applicable. Consult your local gas supplier or propane gas dealer for code regulations and recommended procedures.
- ! The appliance and gas control module must be disconnected from the gas supply piping during any pressure testing of that system at test pressures in excess of 1/2 psig. For pressures less than 1/2 psig, isolate the gas supply piping by closing the manual shut-off valve.
- ! Leak test all gas line joints and the gas control valve prior to and after starting the appliance.

### Gas Line Connection

- Installation must be performed by a qualified installer, service agency, or the gas supplier (In Massachusetts a licensed plumber/gasfitter).
- An accessible manual gas shutoff valve is required on the gas supply to the appliance and must be installed upstream of the appliance gas valve. Check with the local authority having jurisdiction for any additional requirements. A key valve is supplied and installed on the enclosure.
- The supply regulator (the regulator that attaches directly to the residence inlet or the propane tank) should supply gas at the required input pressure detailed in the section "LP Conversion" on page 5. Contact the local gas supplier if the regulator is at an improper pressure.
- The gas should be stubbed into the area under the appliance indicated by the shaded boxes (see diagrams to the right and below).
- If the gas stub is located within 24" of the appliance gas valve the included flex will provide sufficient length to make the connection (see right). If the gas stub is located in the stripped areas additional gas pipe will need to be supplied by the installer.
- The appliance comes with a 34" flex to make the connection from the gas stub-in to the key valve installed on the end of the enclosure.
- The flex accepts 3/4" MPT.

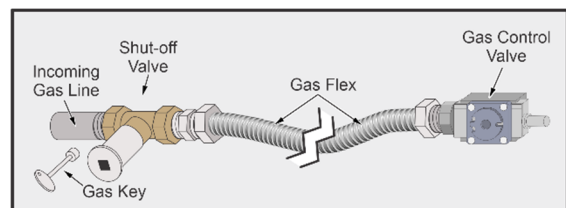

### 48x24 & 72x24 Fire Pits

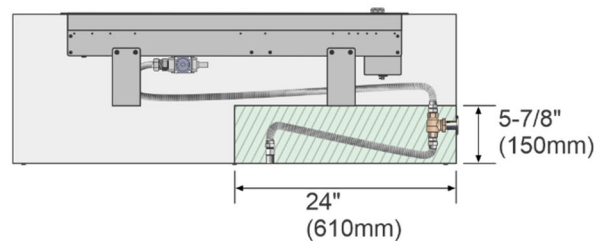

### 108x24 Fire Pits

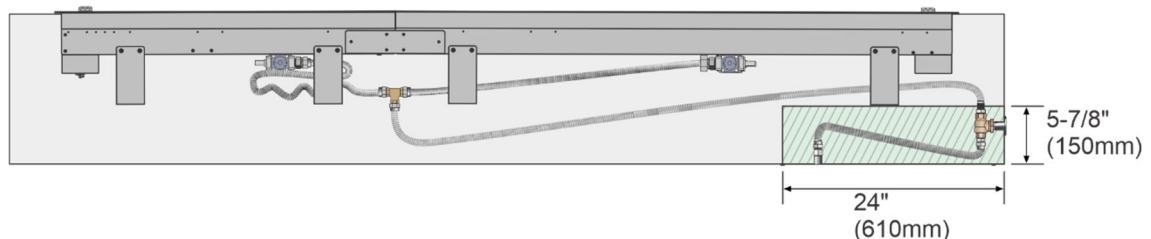

## LP Conversion

The appliance is configured for NG gas from the factory but comes with a kit to convert the unit from natural gas to propane

The LP conversion kit contains:

	Qty.	Size
48x24 Fire Pit	(1)	#41
72x24 Fire Pit	(2)	#43
108x24 Fire Pit	(2)	#43
	(1)	#41

### ! WARNING !

This conversion kit shall be installed by a qualified service agency in accordance with the manufacturer's instructions and all applicable codes and requirements of the authority having jurisdiction. If the information in these instructions is not followed exactly, a fire, explosion, or production of carbon monoxide may result causing property damage, personal injury, or loss of life. The qualified service agency is responsible for the proper installation of this kit. The installation is not proper and complete until the operation of the converted appliance is checked as specified in the manufacturer's instructions supplied with the kit.

- Remove the glass wind guard and glass media (if already installed).
- Remove the media trays (see "Removing the Media Trays" section on page 35)
- Convert the appliance using the instructions to the right.

**a** Remove the manifold cover(s) and gasket(s) that are around the burner orifice(s).

**b** Use an adjustable wrench to support the manifold while removing each orifice with a 1/2" wrench.

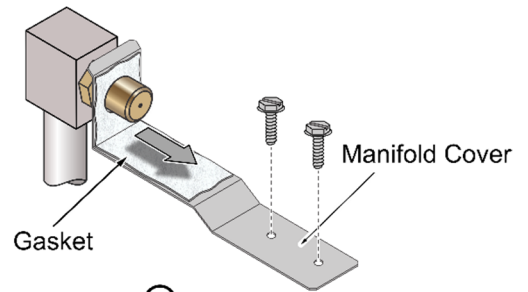
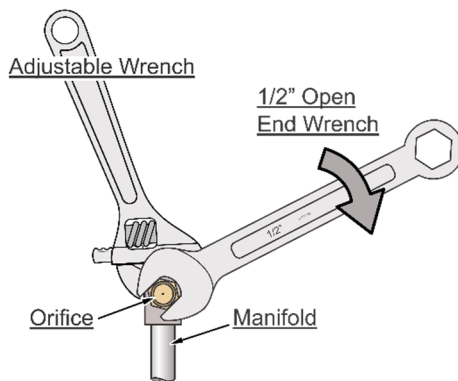

**c** Apply thread sealant to the LP orifices prior to installation. Use the chart in the "Gas Specifications" section to determine the correct orifices.

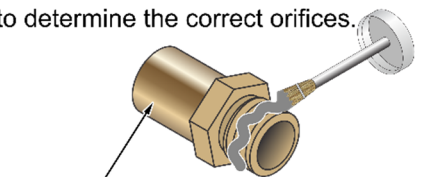

**d** Screw each LP orifice until orifice protrudes 15/16" (23.8mm) indicating full insertion (use wrench to support manifold when re-attaching orifice).

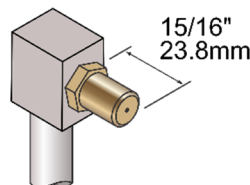

**e** Reference the chart below to determine if the manifold cover & gasket should be reinstalled

	NG	LP
48x24 Fire Pit	✓	✗
72x24 Fire Pit	✓	✗
108x24 Fire Pit	✓	✗

## Electrical Connection Requirements

- ! The appliance, when installed, must be electrically grounded in accordance with local codes, or in the absence of local codes with the National Electrical Code, ANSI/NFPA 70; or the Canadian Electrical Code, CSA C22.1
- ! The electrical line must be installed by a qualified installer and must meet all local codes. Consult your local building official for code regulations and recommended procedures.
- ! The 24VAC transformer may require a circuit protected by a GFCI (see local building codes).
- ! Use a transformer to convert 120VAC power to 24VAC power for the appliance. Supply the transformer with 120VAC at approximately 0.9 amps - make sure the circuit and wiring is appropriately sized. The power supply must be routed through a switch to turn the appliance on and off (see pg. 41). Multiple Travis Industries, Inc. 24-volt appliances may be placed on a single circuit. Each appliance uses 24VAC at approximately 1.6 amps - Make sure the circuit and wiring is appropriately sized (see diagrams starting on pg. 21.). If multiple appliances are powered through a single switch the control modules for each of the individual appliances may be daisy-chained together.

### 24VAC Transformer

- This appliance must be used with a 24VAC switched circuit. The transformer is sold separately.
- Travis Industries offers the following transformer:
  - sku# 94800830 (120v input only with 24v, 26v, and 28v output leads). See the instruction sheet included with the transformer for details.

See the overview to the right. Consult the instruction sheet that comes with the transformer for details.

Transformer Junction Box

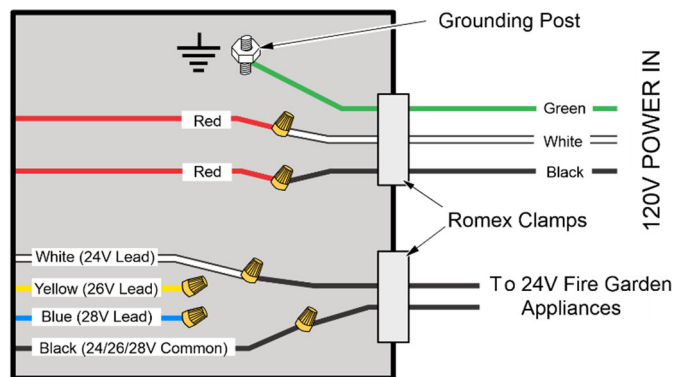

**NOTE:** In this example the 24V Lead is used.

**WARNING:** Make sure to put wirenuts on un-used power leads (in this example the 26V and 28V Leads)

## Installation Details

We recommend outdoor-suitable electrical connectors (silicone-filled wire connectors, dielectric grease, etc.) on the power-in connections to the control module to prevent corrosion.

- Remove the (2) 1/4" screws that secure the media tray ends to the media tray sides (set aside for reinstallation). Remove the media tray end with the pilot cover attached.

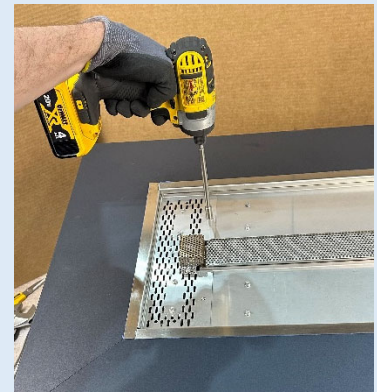
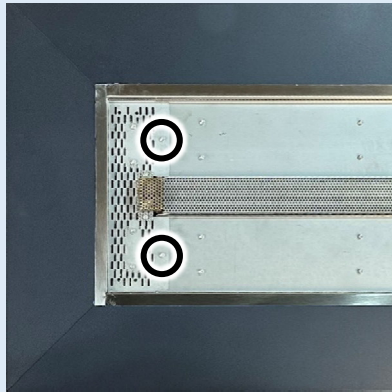

- Lift the media tray end and set it aside for reinstallation

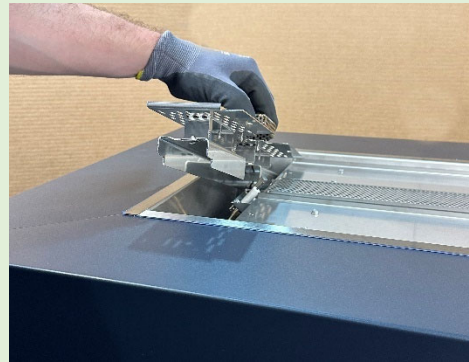

- Repeat the previous (2) steps with the other end media tray.

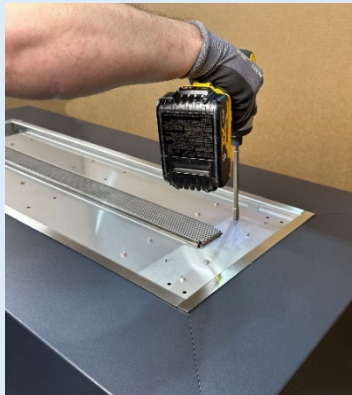



- There are (4) screws that secure the burner tray to the enclosure (see pictures below). Use a 1/4" driver to remove the screws. Set the screws aside for reinstallation.

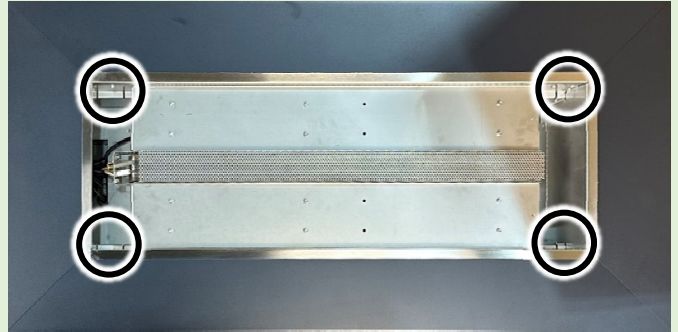
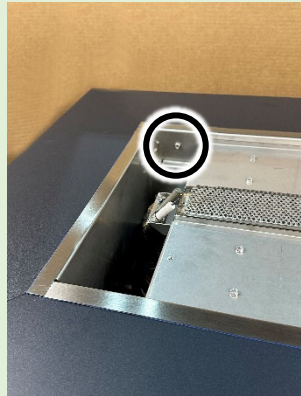

- Grab the burner assembly by the media trays on either end. Lift the burner assembly out of the enclosure.



- Set the firepit enclosure over the incoming gas supply and low voltage electrical supply wires from the required 24v transformer.

- Spread a blanket or cardboard over the top of the enclosure to protect the powder coat finish and rest the burner assembly on the blanket diagonally over the opening of the enclosure that you lifted it out of.



- Cut the zip ties that secure the coiled up gas flex line on the burner tray assembly and the coiled up flex line attached to the key valve on the firepit enclosure.



- Connect the gas flex from the key valve (preinstalled on the inside of the enclosure) to the incoming gas supply line.



- Connect the Gas flex from the burner assembly to the pre-installed key valve.

**NOTE:** Leak test all joints before putting the firepit into service.



## 108x24 Fire Pit ONLY



With the 108X24 fire pit only, the installer must install the gas “tee” fitting as well as the flex from the tee to the key valve (see illustration below). The tee and flex are included and shipped in the appliance hardware pack. Make sure to leak test these connections.

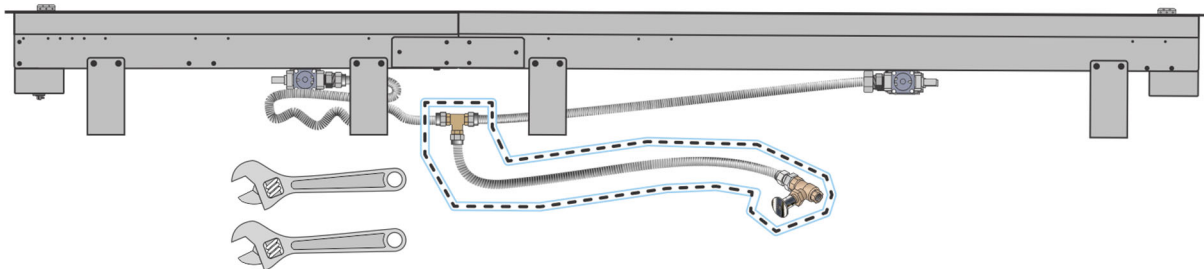

- Route the wires from the 24VAC transformer up through the opening in the enclosure and through the strain relief on the bottom of the electrical junction box (below the igniter). Use listed low voltage wiring. Make sure to provide slack in the wire for removal and service. Use wire nuts to connect the low voltage wires to the white and yellow/white striped wires from the control module.



- Use wire nuts to connect the wires from the 24VAC transformer to the yellow and the yellow/white striped wires on the control module (polarity does not matter for this connection). When the connections are secure, coil the wires and push them back into the electrical box.



Make sure wires are in the electrical box under the burner tray. This will ensure they do not touch anything hot.

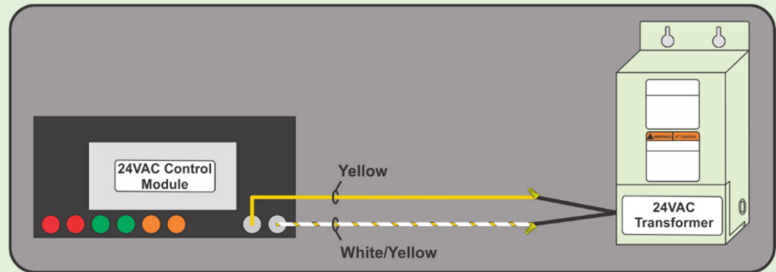
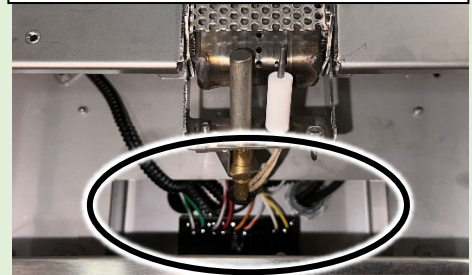

- Set the burner assembly into the enclosure. Take care not to scratch the powder coat on the enclosure.



- Reinstall the screws that secure the burner assembly into the enclosure.



- Reinstall the end media tray covers and secure them to the appliance with the screws removed earlier.

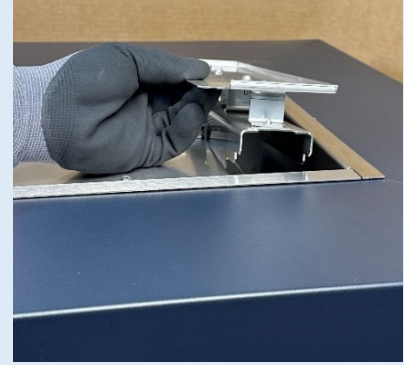
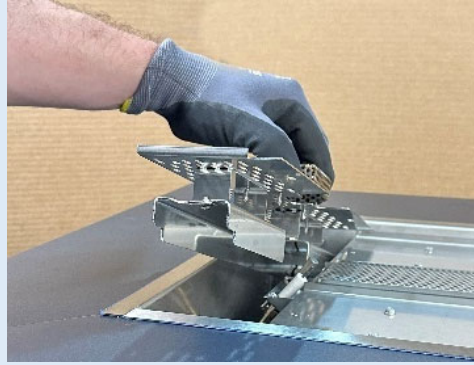

- The appliance uses approximately 40 watts during startup (1.6 amps at 24 VAC). Make sure the circuit and wires are sized appropriately. The appliance requires a minimum of 22 VAC to operate (if the voltage drops below this, the appliance may not start).

## Using More than One 24-volt Appliance

Travis Industries, Inc. manufactures additional 24-volt appliances that can add to the ambiance of your outdoor space (Tempest Torch™, Tempest Lantern™. Visit [tempesttorch.com](http://tempesttorch.com) for more details). If using more than one appliance, make sure to think about how the appliances will be used and if they need to be able to be controlled separately or if it would be more convenient to control them all using one switch. The following pages show examples of multi appliance installation options using one switch and powering more than one appliance using the same transformer. If you are planning an installation using two or more appliances, be sure to pay close attention to the wiring sizing detailed in this section.

## Wiring Multiple Transformers to One Switch

- Multiple 24VAC transformers may be wired to a single switch (see diagram below).

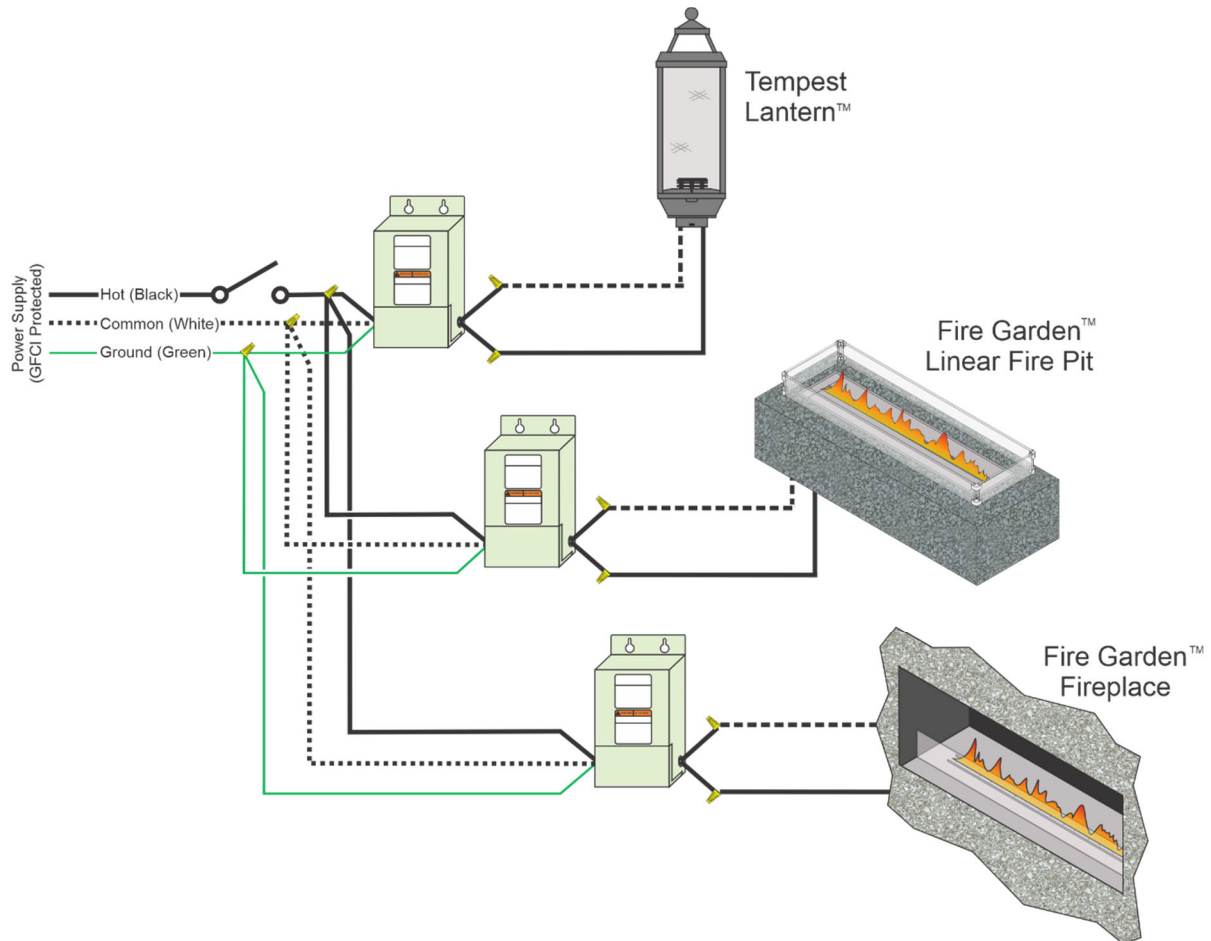

## ***Wiring Multiple Appliances to One Transformer***

The manner in which you wire the appliances to the transformer affects the maximum length of wire and wire gauge. Make sure to determine the wire configuration before installation. NOTE: You may use both direct-run and daisy-chain configurations.

### ***Daisy-Chain Example***

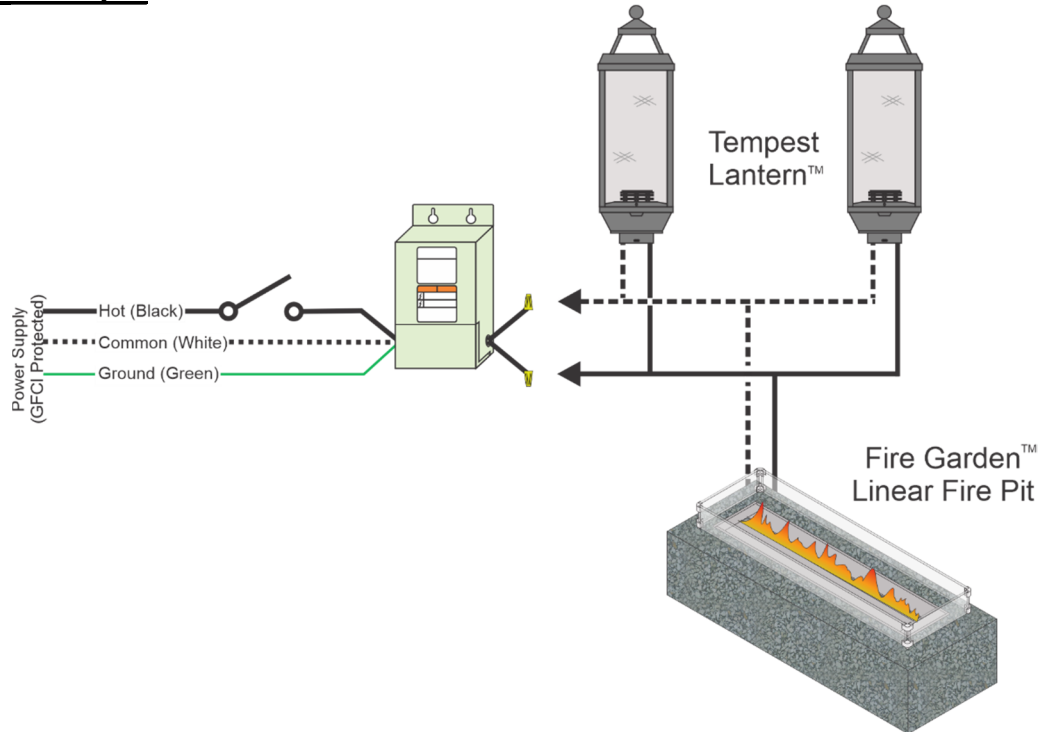

### ***Direct-Run Example***

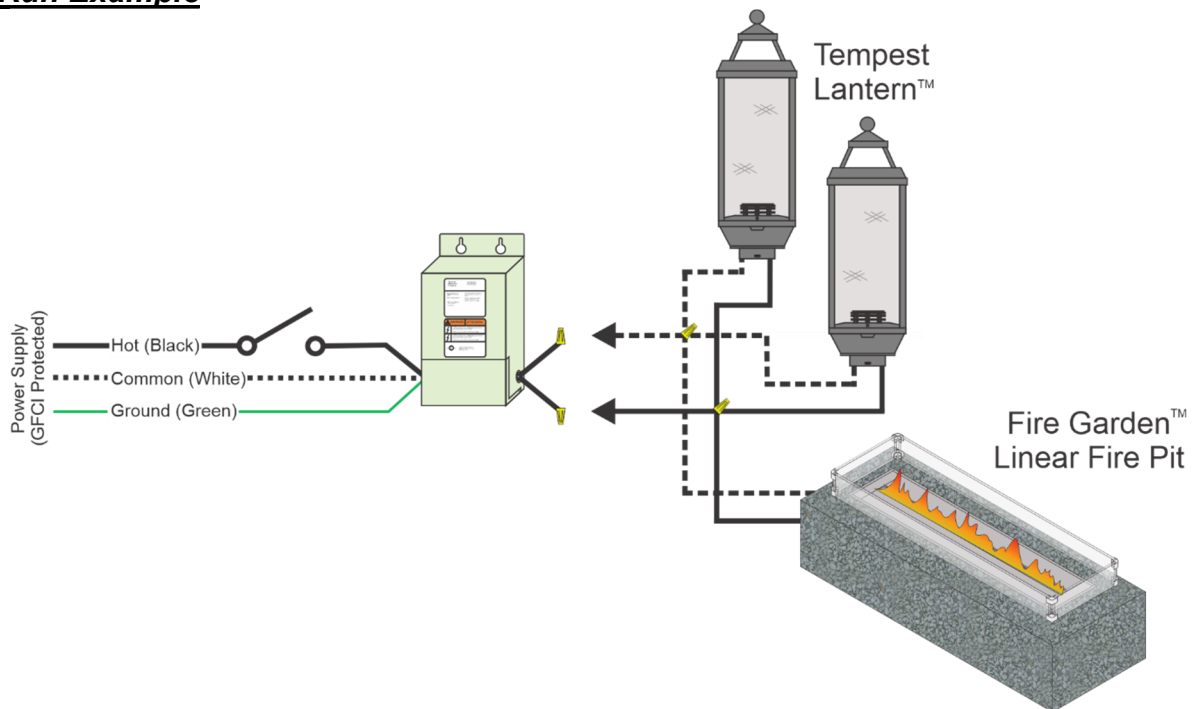

## Daisy-Chain Wire Length Chart

This type of wire configuration allows for multiple Travis Industries 24-volt products to be wired in a series, reducing the amount of wire used. Use the charts below to determine the correct wire gauge and length. In the example below, the transformer has 2 Linear Fire Pits and a lantern on one branch.

### How to Calculate Wire Length:

Add together all of the wire length(s) used for the entire installation. If you have one 80' length and three 20' lengths, your wire length would be 140'.

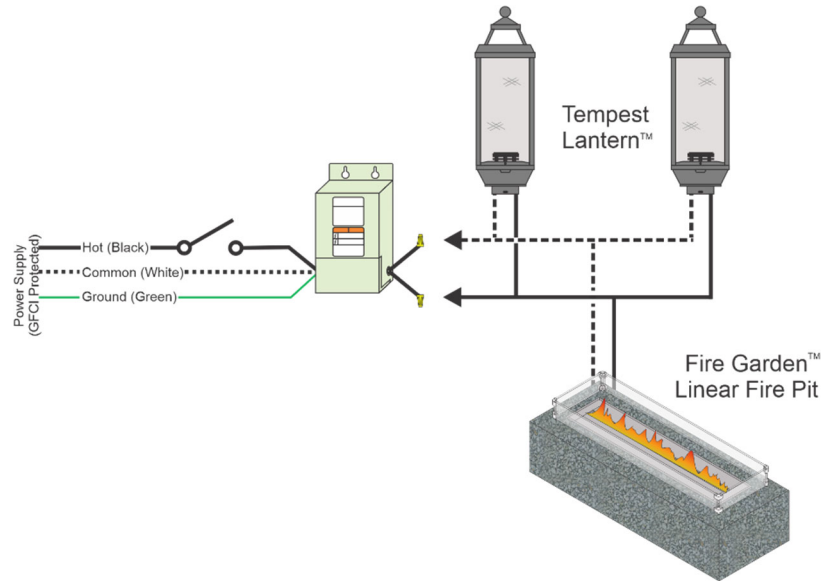

### 24 Volt Lead

Wire		# of appliances on branch				
		2	3	4	5	6
14 GA	min	0'	0'	0'	0'	0'
	max	113'	71'	49'	37'	28'
12 GA	min	0'	0'	0'	0'	0'
	max	173'	108'	75'	55'	43'
10 GA	min	0'	0'	0'	0'	0'
	max	266'	165'	115'	85'	65'

### 26 Volt Lead\*

Wire		# of appliances on branch				
		2	3	4	5	6
14 GA	min	27'	10'	1'	0'	0'
	max	184'	118'	85'	65'	51'
12 GA	min	41'	16'	2'	0'	0'
	max	281'	179'	129'	99'	79'
10 GA	min	63'	23'	3'	0'	0'
	max	432'	276'	198'	151'	121'

### 28 Volt Lead\*

Wire		# of appliances on branch				
		2	3	4	5	6
14 GA	min	104'	62'	40'	27'	19'
	max	242'	157'	113'	88'	71'
12 GA	min	160'	94'	61'	41'	28'
	max	369'	238'	173'	134'	108'
10 GA	min	245'	144'	93'	63'	43'
	max	566'	366'	266'	206'	165'

\* Not available on some transformers.

## Direct-Run Wire Length Chart

This type of wire configuration allows for long distances between the transformer and the appliances (see illustration below). Use the charts below to determine the correct wire gauge and length.

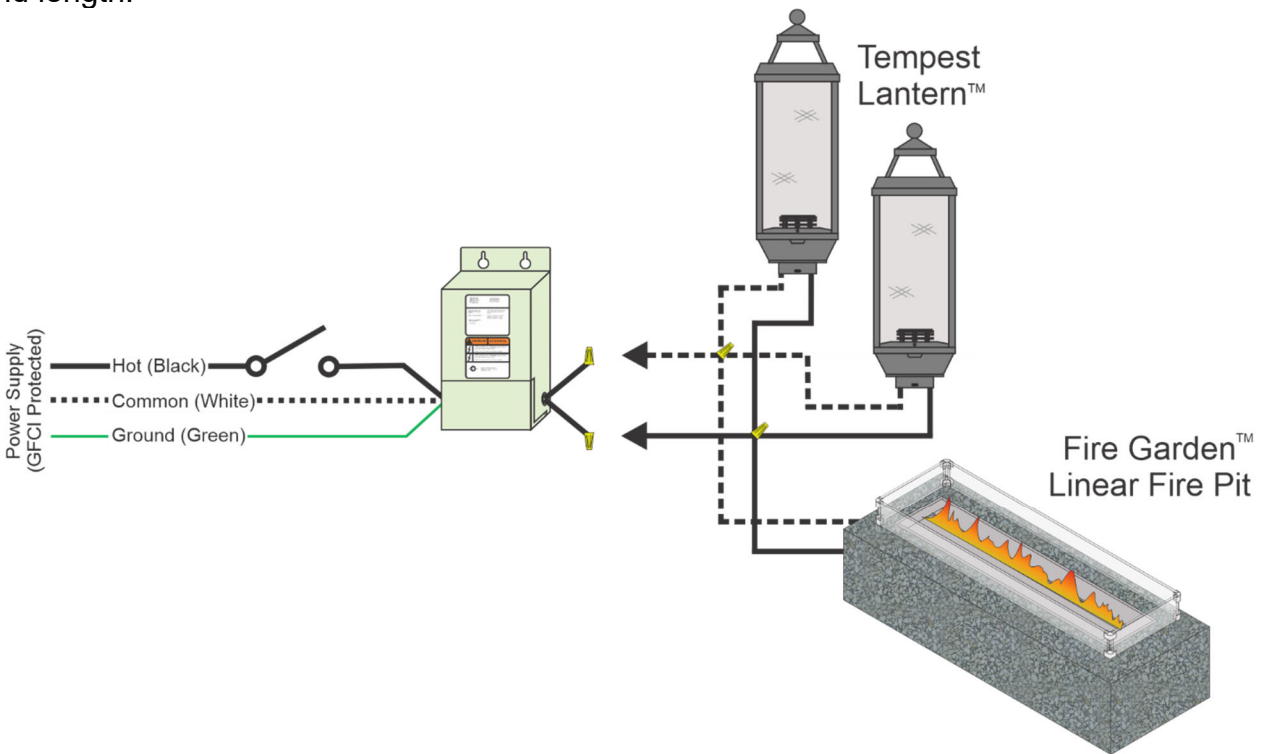

### 24 Volt Lead

Wire		
14 GA	min	0'
	max	242'
12 GA	min	0'
	max	369'
10 GA	min	0'
	max	566'

### 26 Volt Lead\*

Wire		
14 GA	min	79'
	max	384'
12 GA	min	120'
	max	584'
10 GA	min	184'
	max	897'

### 28 Volt Lead\*

Wire		
14 GA	min	234'
	max	499'
12 GA	min	356'
	max	760'
10 GA	min	548'
	max	1168'

\* Not available on some transformers.

## Wiring Examples:

### Daisy-Chain Installations:

- When using 3 appliances on one branch, 14 ga wire, and 150' of wire, use the 28V Lead.
- When using 4 appliances on one branch, 10 ga wire, and 100' of wire, use the 24V Lead.

### Direct Run Installations:

- When using an appliance on a 200' run, 14 ga wire, use the 24V Lead.
- When using 6 appliances, each on a 200' run, 14 ga wire, use the 24V Lead.

**How to Determine Wire Gauge:** When purchasing your wire, it should include a wire gauge (the larger the number, the smaller the diameter wire). The wire will also be printed with a gauge number (e.g., AWG#14 = 14 gauge, 10AWG = 10 gauge, etc.). Do not use wires of dissimilar gauges (do not use 14 gauge & 10 gauge wire on the same transformer).



## Steps for Finalizing the Installation

1. If using propane (LP) gas, convert the appliance (prior to installing the crushed glass).
2. We recommend you purge the gas line at this time.
3. Leak test all gas joints.
4. Install the burner (if removed for converting to LP gas).
5. Test burn the appliance
6. Assemble the Glass Wind Guard (do not install the Wind Guard until the last step).
7. Install the crushed glass, Lava Rock, or Tumbled Stone media.
8. Install the Glass Wind Guard

## Crushed Glass Installation

Crushed glass is placed over the burners and center media trays. Use only ¼" crushed glass from Travis Industries and/or other media specifically approved by Travis Industries.

### Placing Crushed Glass on the Burner and Center Media Trays

<b>Glass Quantity Needed</b>	<b>48x24 Fire Pit</b>	10 lbs. (4.54 kg)
	<b>72x24 Fire Pit</b>	25 lbs. (11.34 kg)
	<b>108x24 Fire Pit</b>	50 lbs. (22.64 kg)

**1 Level Cup (8 fl. oz.) (240ml) = 0.95 lbs.  
So...1 Slightly Rounded Cup = 1 lb.**



Determine the amount of glass needed for the appliance being installed. Set this glass aside in portions to allow for an even amount of glass to be placed over the surface of the burner and media tray. **NOTE:** It is better to install too little glass than too much.

- (a) Open up a bag of crushed glass and pour it evenly onto the burner and media trays. Use a brush or glove to evenly distribute the glass over the surface.

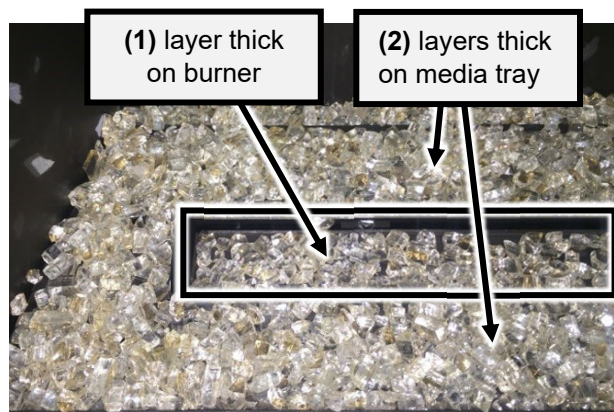

- (b) Spread an even layer of crushed glass over the media tray and burner. The glass must be only (1) layer thick on the burner but can be (2) layers thick on the media tray. Excessive glass placed on the burner may cause poor burn characteristics and can lead to sooting and/or delayed ignitions.

## 26 Finalizing the Installation (qualified installers only)

### Rock Ember Installation

Rock embers can be placed over the burners and center media trays. Use only the Rock Ember material from Travis Industries and/or other media specifically approved by Travis Industries.

#### ***Placing Rock Embers on the Burner and Center Media Trays***

Rock Ember Quantity Needed	48x24 Fire Pit	5 lbs. (2.27 kg) small & 10 lbs. large (4.54 kg)
	72x24 Fire Pit	10 lbs. (4.54 kg) small & 20 lbs. large (9.07 kg)
	108x24 Fire Pit	20 lbs. (9.07 kg) small & 40 lbs. large (18.14 kg)

Approx. 2-1/2 Level Cups (8 fl. oz.) (240ml) = 1 lb.



**NOTE:** We recommend painting the burner and media tray with black high temperature stove paint prior to installing the Rock Embers in order to disguise the stainless steel so it is not as noticeable between the Rock Embers.

1. Determine the amount of small Rock Embers needed for the appliance being installed. Set the Rock Embers aside in portions to allow for an even amount of the material to be placed over the surface of the burner and media tray. Discard rock at the bottom of the bag that has disintegrated (turned into small, sand-like material).

**NOTE:** It is better to install too little material than too much.

2. Place a single layer of Ember Rock on the burner. Do not place large rocks over any burner ports. This will cause sooting. If there are large pieces of rock move them off the burner and place them on the media tray.
3. Place a double layer of Ember rock on the media tray

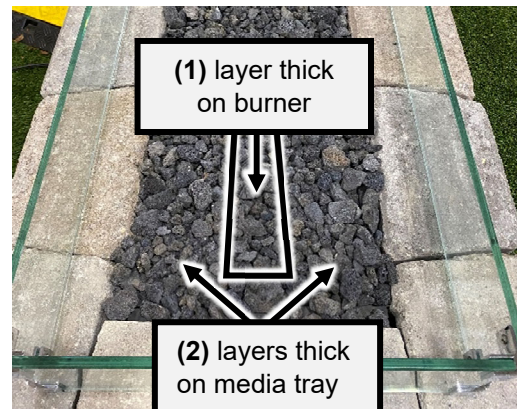

## ***Tumbled Stone Installation***

Tumbled Stone may be placed over the burners and media trays. Only use the Tumbled Stone media kit from Travis Industries. The amount of stone indicated on the chart below refers to the small stones used to cover the burner and media tray. Large stones may be placed anywhere over the media tray but should not be installed over the burner and are not included in the recommended weights in the chart below.

### ***Placing Tumbled Stone on the Burner and Media Trays***

<b>Small Tumbled Stone Quantity Needed</b>	<b>48x24 Fire Pit</b>	30 lbs. (13.61 kg) small & 20 lbs. large (9.07 kg)
	<b>72x24 Fire Pit</b>	50 lbs. (22.68 kg) small & 20 lbs. large (9.07 kg)
	<b>108x24 Fire Pit</b>	100 lbs. (45.36 kg) small & 40 lbs. large (18.14 kg)

**NOTE:** We recommend painting the burner and media tray with black high temperature stove paint prior to installing the stones in order to disguise the stainless steel so it is not as noticeable between the stones.

- Determine the amount of small stones needed for the appliance being installed. Distribute the stones to disguise the stainless steel. The stones may be placed in a double layer over the media tray but should be only a single layer over the burner.
- Large stones may be placed anywhere on the media tray that is aesthetically pleasing but should not be placed over the burner.

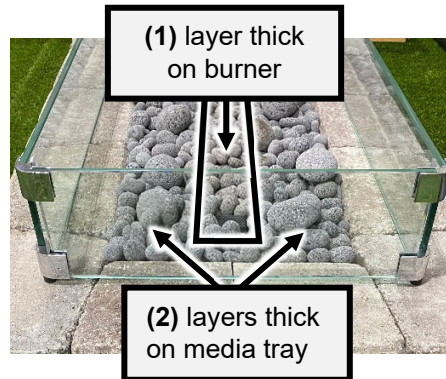
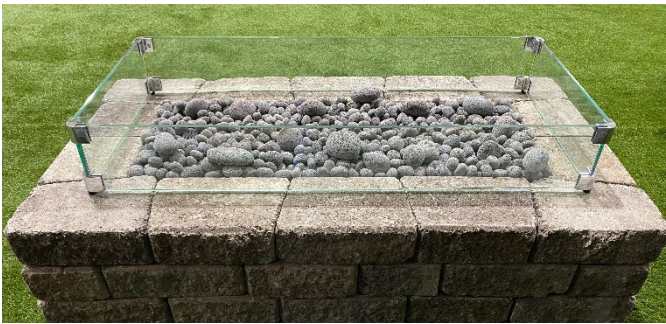

## 28 Finalizing the Installation (qualified installers only)

### Assembling the Glass Wind Guard

#### Assembling the Glass Wind Guard (48" & 72" units)

The fire pit wind guard must be used for all fire pit installations. The wind guard consists of the following parts:

- (4) Top brackets
- (4) Bottom brackets with rubber feet
- (2) Glass end panels
- (2) Glass side panels

Assemble the wind guard following the steps below.

**NOTE:** Assemble the wind guard assembly on a flat surface and use (2) people to lift it assembled wind guard and set it in place around the linear burner.

1. Lay the glass panels out on cardboard or another soft surface that can support the full length and width of the glass and protect them.

2. Attach the (2) top and (2) bottom brackets as shown to the right (the bottom brackets have rubber feet on them, the top brackets do not). Use a standard screwdriver to secure the brackets to the glass panel (Take care not to overtighten). Repeat this step with the second end piece of glass.

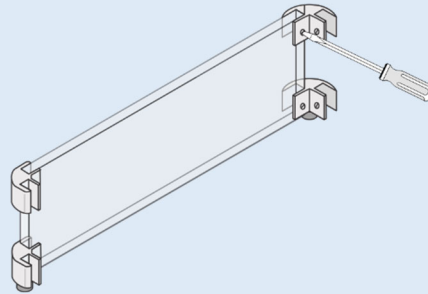

3. Slide the end panels onto the properly oriented side panels and secure the brackets to the glass as shown to the right.

**NOTE:** There are Fire Garden logos on the side pieces of glass. The logos should be in the lower right corner when the glass is oriented properly.

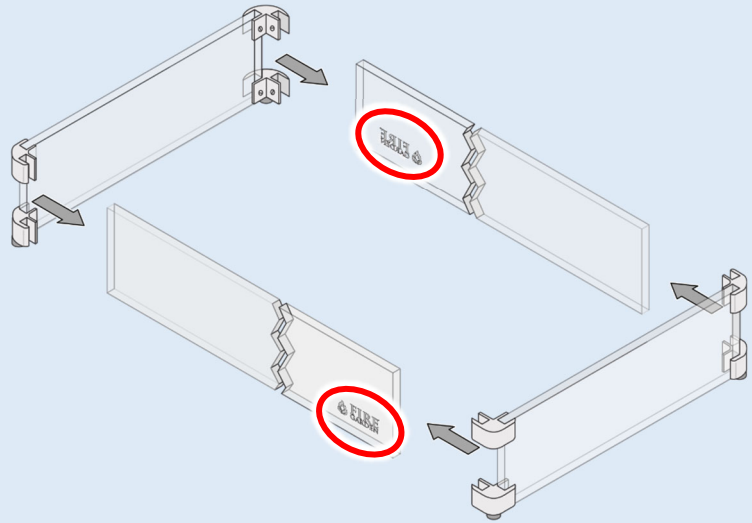

4. When all the clamps are secure use (2) people to lift the assembly and place it on the fire pit enclosure. Measure the distance from the edges of the fire pit enclosure to the edges of the glass to ensure that it is centered.

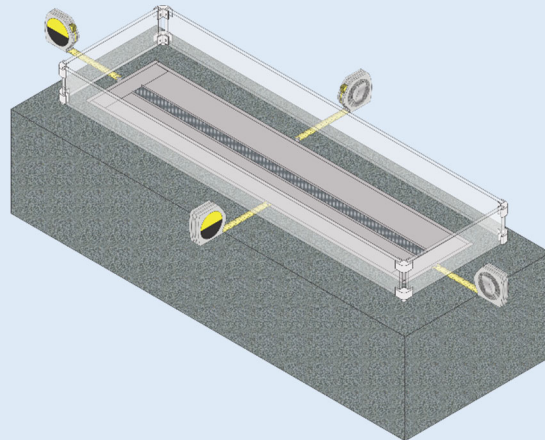

## Assembling the Glass Wind Guard (108" units)

The fire pit wind guard must be used for all fire pit installations. The wind guard consists of the following parts:

- (4) Top corner brackets
- (4) Bottom corner brackets with rubber feet
- (2) Top middle brackets
- (2) Bottom middle brackets with rubber feet
- (2) Glass end pieces
- (2) Glass side pieces with Fire Garden logos
- (2) Glass side pieces without logos.

Assemble the wind guard following the steps below.

**NOTE:** Assemble the wind guard assembly on a flat surface and use (2) people to lift it assembled wind guard and set it in place around the linear burner.

1. Lay the glass panels out on cardboard or another soft surface that can support the full length and width of the glass and protect them.

2. Attach the (2) top and (2) bottom corner brackets as shown to the right (the bottom brackets have rubber feet on them, the top brackets do not). Use a standard screwdriver to secure the brackets to the glass panel (Take care not to overtighten). Repeat this step with the second end piece of glass.

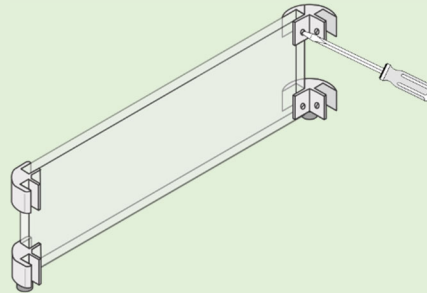

3. Attach the (2) top and (2) bottom middle brackets as shown to the right (the bottom brackets have rubber feet on them, the top brackets do not). Use a standard screwdriver to secure the brackets to the glass panel (Take care not to overtighten). Repeat this step with the second end piece of glass.

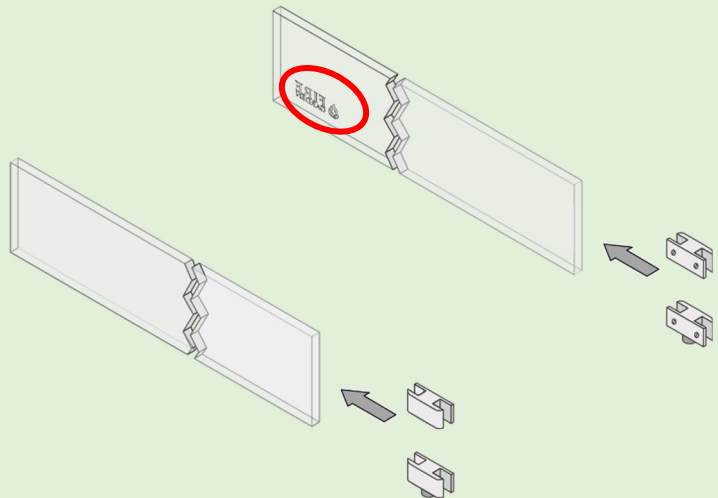

**NOTE:** There are Fire Garden logos on (2) of the (4) side pieces of glass. For this step, make sure to use one with the logo and one with no logo. When installing the brackets on the glass panel with the logo, make sure that the brackets are on the opposite end from the logo (see illustration to the right).

## 30 Finalizing the Installation (qualified installers only)

- Place the side glass panels from the previous step into the corner brackets previously installed onto one of the end panels. Use a standard screwdriver to secure the brackets to the glass panel (Take care not to overtighten). Repeat this step with the second end piece of glass.

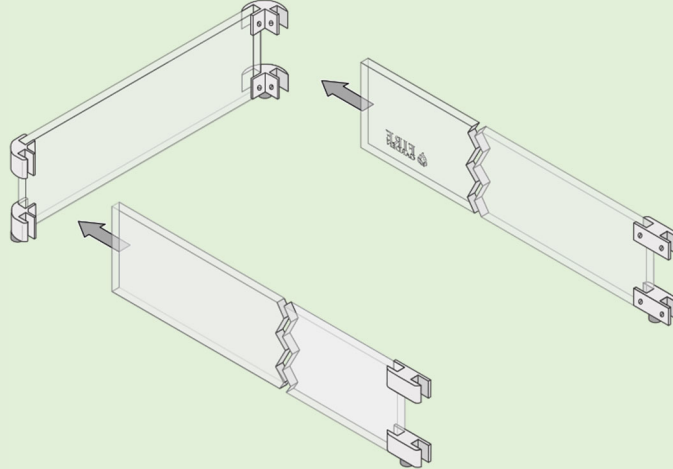

**NOTE:** Make sure the logo is readable when looking at the outside of the wind guard.

- Repeat the step above with the (2) side panels without the middle brackets and the other end panel.

**NOTE:** Make sure that the logo is on the opposite side as the one in the previous step and is readable when looking at the outside of the wind guard.

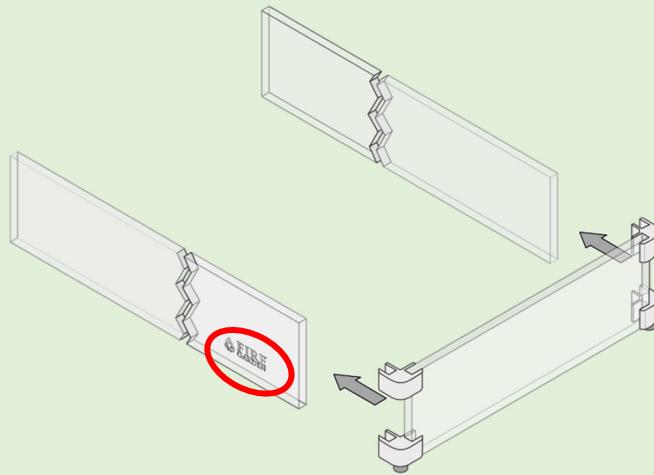

- Put the (2) halves of the wind guard together and secure them by tightening the set screws on the center brackets. Make sure not to overtighten the screws.

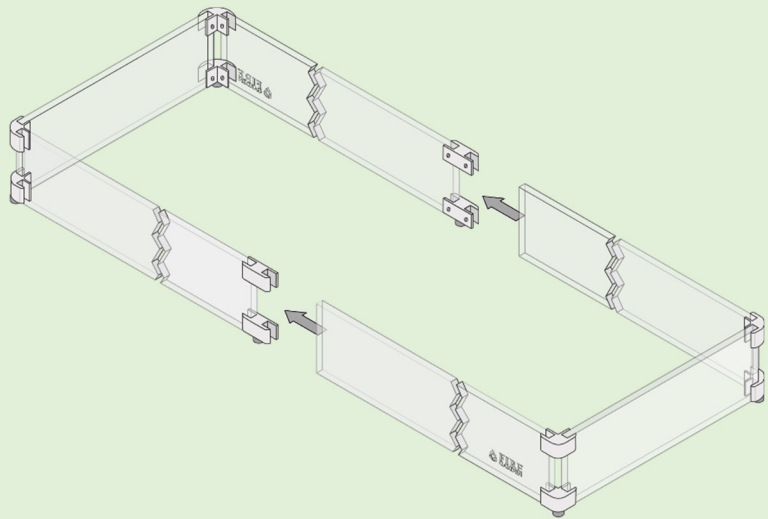

6. When all the clamps are secure use (2) people to lift the assembly and place it on the fire pit enclosure. Measure the distance from the edges of the fire pit enclosure to the edges of the glass to ensure that it is centered.

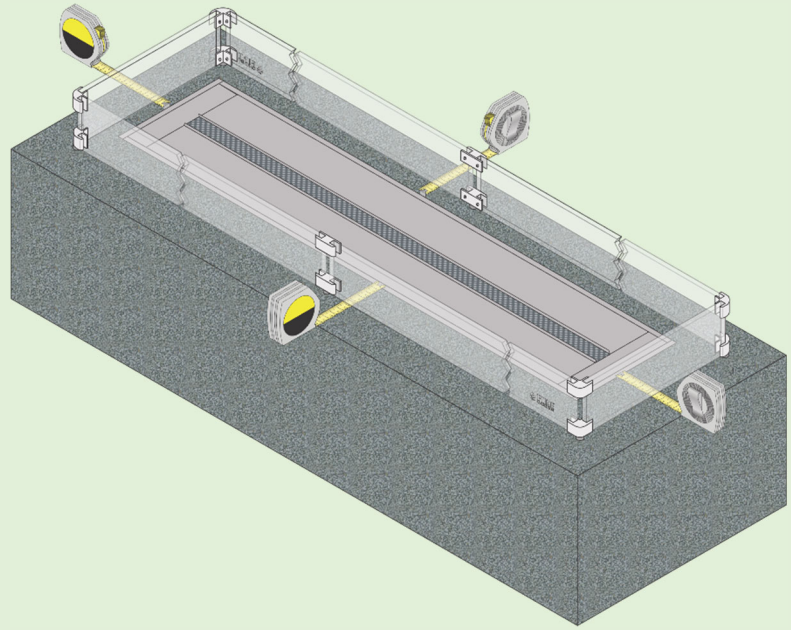

### ***Before the First Fire***

---

- ! Read this entire manual before you use your new appliance, especially the section "Safety Precautions" on page 4. Failure to follow the instructions may result in property damage, bodily injury, or even death.
- ! Remove any cover from the appliance prior to operation.
- ! Inspect the appliance to make sure it is free of debris or objects that may have fallen into the appliance prior to operation.
- ! Inspect the appliance, burner, and supply lines for any damage prior to operation. The burner must be replaced prior to the appliance being put into operation if it is evident that the burner is damaged. Use only Travis Industries replacement burners.
- ! It may be difficult to see the burner operating in direct sunlight.

### ***Operating Instructions***

---

**WARNING:** This gas appliance is automated, it runs off an electric ignition system and may not be lit with a lighter or matches.

#### ***How your appliance works***

##### **Ignition**

When you switch the appliance on, electrical power is supplied to the control module, starting the ignition sequence. During ignition, the igniter will heat up. Gas is then turned on to the appliance. The appliance will ignite and the thermopile will signal the control module that the appliance is lit and the igniter will then turn off.

**NOTE:** In rare cases, the appliance will fail to light. In these cases, the appliance will wait 30 seconds, then re-start the 30-second ignition sequence. The control module will try to restart the appliance a total of 3 times. If it fails to light after three tries, the appliance will then shut off. To re-start, turn the switch off, wait 5 minutes, then turn the switch on.

##### **Appliance in Operation**

The appliance, once lit, will stay lit until the switch is turned off. If the gas flow is interrupted, or if wind blows out the flame, the appliance will start the 1-1/2 minutes (90 second) ignition sequence.

##### **Safety Circuit**

Each appliance has a built-in safety circuit that only allows gas to flow during the ignition sequence and when the appliance is lit. This prevents gas buildup. The safety circuit relies upon a thermopile to keep the gas valve open. If the flame goes out the control module will shut the gas off then try to relight the appliance. Your appliance can not be operated manually, if a problem persists consult the troubleshooting guide (pg. 39) and call a qualified service technician if needed.



## Location of Controls

- Use the wall switch to supply power to the appliance. The appliance will automatically light when power is supplied (The location of the switch is specific to your installation).

Off

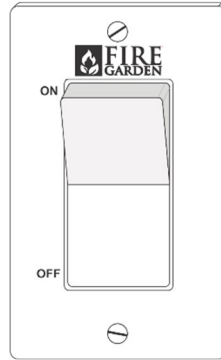

On

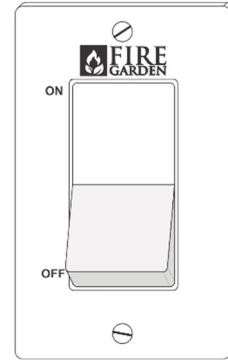

- If the wall switch will be located where it is not protected from precipitation, it must be installed in a weather resistant enclosure (not included).

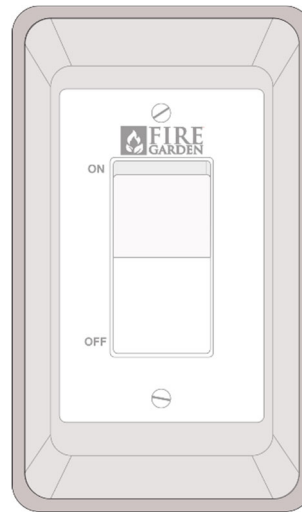

## Maintaining Your Appliance

! **Failure to inspect and maintain may lead to malfunctioning of the appliance and potentially dangerous situations.**

- Inspect the appliance prior to each use.
- Keep the appliance clean and remove any debris that collects in or on the appliance. Inspect for spiders and insects, they may clog burner ports or air inlets and need to be removed before using.
- Have the appliance inspected by a qualified service technician annually.
- The stainless steel burner top will discolor – this is normal.

Your appliance is designed to be easily cleaned and maintained. The most common maintenance that your appliance will require is cleaning the glass wind guard. Clean with glass cleaner or warm soapy water. The glass wind guard on the appliance is tempered and designed for safety. If the glass breaks it will shatter into small square pieces similar to a car window. It is special glass and if you break one or need to replace a piece of glass, use only 3/8" thick tempered glass supplied by your Fire Garden™ dealer.

### **Glass Cleaning**

**The appliance must be completely cool before cleaning the glass.**

The glass may be cleaned with a non-abrasive cleaner. To clean the inside of the glass, remove the glass, place it on a non-scratching surface, and clean the inside surface.

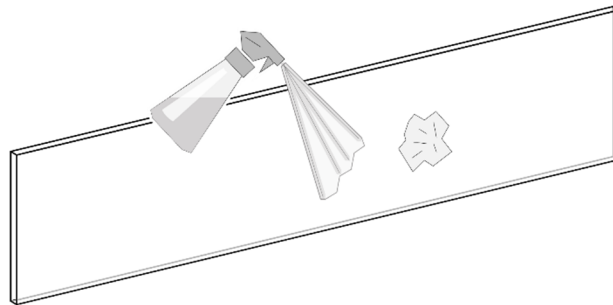

## Accessing Components

### ! WARNING !

Disconnect power before attempting maintenance or repair.

The gas valve and electrical components are located under the burner tray. To access the components, follow the steps below.

### Removing the Media Trays

- Remove the glass wind guard and all the crushed glass media (if already installed).

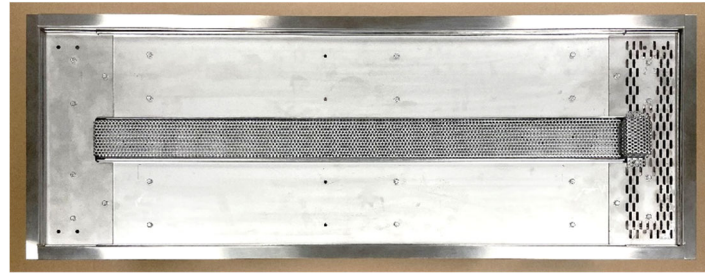

- Remove the (4) 1/4" screws that secure the media tray ends to the media tray sides (2 on each end). Lift the media tray end pieces out of the appliance and set them aside for reinstallation.

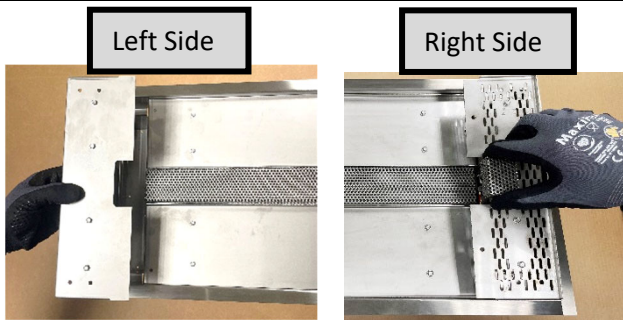

- Remove all the screws from the media tray(both sides) and remove the trays.

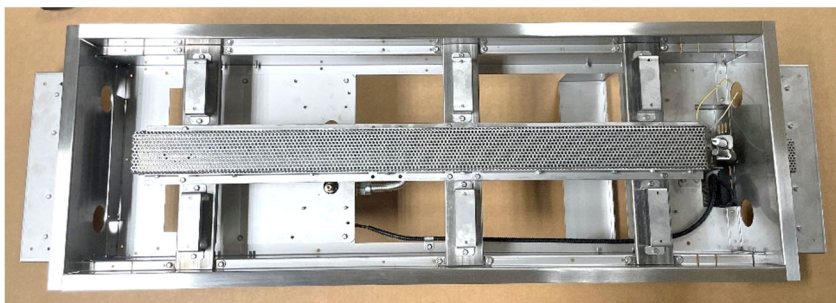
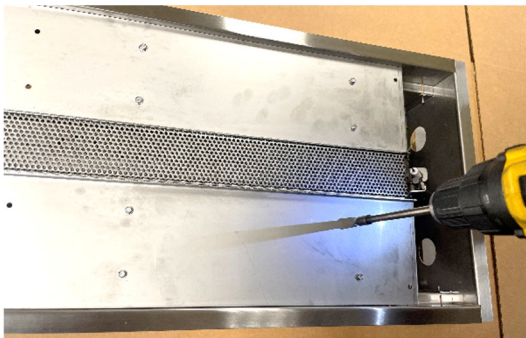

**Accessing the Pressure Tap**

**NOTE:** If you are accessing the pressure tap to take a manifold pressure reading only, it is now accessible and you do not need to remove the rest of the burner. **If you are trying to gain access to the other components, skip this step and proceed to the next section.**

- Locate the pressure tap shown to the right. It is approximately in the center of the appliance.
- Use a manometer to test the gas manifold gas pressure.

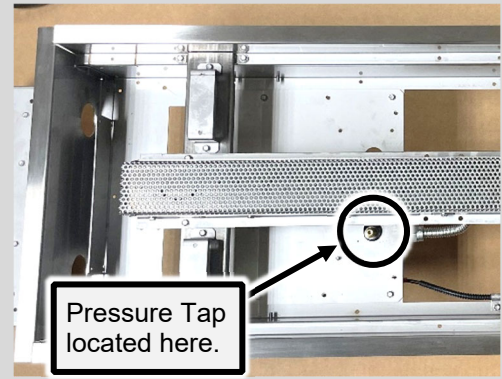
**Removing the Burner**

**NOTE:** If you are accessing the gas or electrical connections you do not need to remove anything else on the top portion of the burner tray. **If you are trying to gain access to the orifice(s) to convert the appliance to LP gas, follow the steps below.**

- Remove the screws that secure the burner to the tray assembly (8 for a 36" appliance or 12 for a 60" appliance, and 24 for a 120" appliance). Set screws aside for reinstallation.

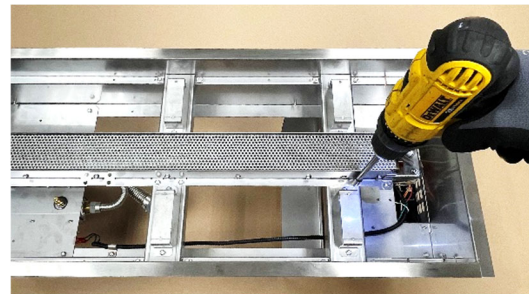

- Lift the burner out of the appliance and set it aside for reinstallation.

**Accessing Pilot Components**

- Remove the (2) 1/4" screws that secure the media tray end to the media tray sides. Lift the media tray end piece out of the appliance and set it aside for reinstallation.

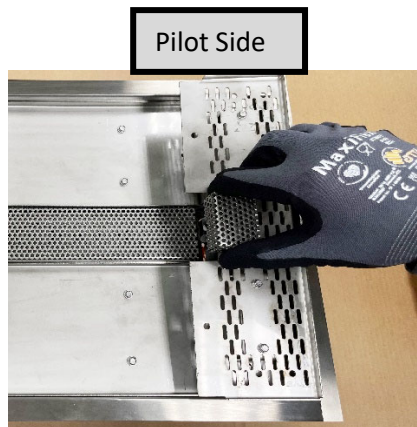

- Use an 11/32" nut driver to remove the nut that secures the thermopile and a 1/4" nut driver to remove the nut that secures the ignitor. Disconnect the component wires from the control module and remove them from the appliance.



- Once maintenance or testing of components is complete, follow the above steps in reverse to return the appliance to its proper configuration.

## Winterizing the Appliance

### ⚠ WARNING ⚠

**THE GAS MUST BE TURNED OFF IF A COVER IS INSTALLED ON THE APPLIANCE.**

In areas where the appliance may not be used in winter, or for an extended period, you may wish to cover the appliance. If a cover is used you **MUST** shut off gas to the appliance. This will ensure the appliance is not accidentally turned on or started with debris or snow inside the appliance.

**Failure to turn off the gas when the appliance is covered can create a severe safety hazard and may result in property damage, personal injury, or loss of life**

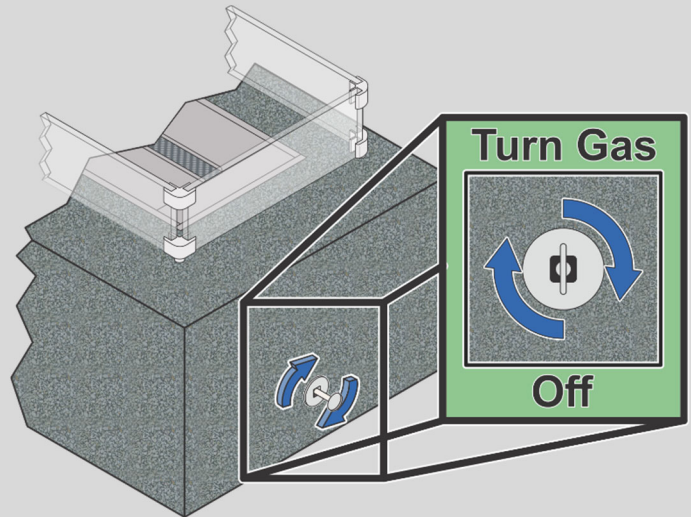

## Yearly Service Procedure

**DANGER HIGH VOLTAGE:** Disconnect power before attempting maintenance or repair.

- Failure to inspect and maintain the appliance may lead to improper combustion and a potentially dangerous situation. We recommend the following procedures be done by a qualified technician.

**THIS APPLIANCE IS NOT USER SERVICEABLE:** Contact your dealer for service.

Inspect the pilot flame. The top 1/4" of both the thermopile and igniter should be within the flame. If it is not, contact your dealer for service.

Shut off the gas to the appliance and let it cool for 15 minutes.

Remove crushed glass. If excessive sooting is found, the appliance will require adjustment. Contact your dealer.

Inspect the burner and remove any debris.

- Make sure the burner is not warped, cracked, or damaged.
- Check the firebox and area around the pilot to make sure there is no warping or damage.
- If any problem is found, discontinue use and contact your dealer for service.
- Replace the crushed glass.

Check the gas control valve and the gas lines. If damage is found, discontinue use and contact your dealer for service.

Start the main burner. After 15 minutes, the flames should be orange/yellow. If the appliance is not burning correctly, contact your dealer for service. If the igniter is not getting hot or lighting the appliance properly contact your dealer for service.

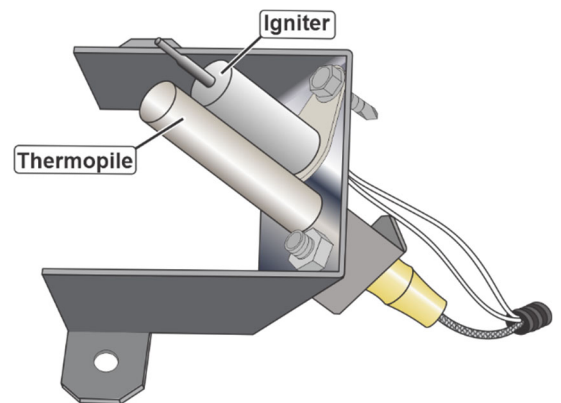

**Replacement Parts List**

**Caution:** Use only Travis Industries replacement parts. Do not use substitute materials.

**Warning:** Do not operate the appliance with the glass wind guard removed, cracked, or broken. Replacement of the glass should be done by a licensed or qualified service person.

Replacement Parts	
48x24 Fire Pit – WIND GUARD GLASS - FRONT/REAR - 38-7/8" x 6" (Qty 1)	250-05774
72x24 Fire Pit - WIND GUARD GLASS - FRONT/REAR - 62-7/8" x 6" (Qty 1)	250-05708
108x24 Fire Pit - WIND GUARD GLASS - FRONT/REAR - 49-1/8" x 6" <u>NO LOGO</u> (Qty 1)	250-06199
108x24 Fire Pit - WIND GUARD GLASS - FRONT/REAR - 49-1/8" x 6" <u>WITH LOGO</u> (Qty 1)	250-06198
WIND GUARD GLASS - SIDE - 14-7/8" x 6" (Qty 1)	250-05707
GAS CONTROL VALVE	250-05704
THERMOPILE	250-04550
IGNITER	250-04549
CONTROL MODULE	250-05703
BURNER ORIFICE - (#41)	250-04625
BURNER ORIFICE - (#43)	250-00398
WALL SWITCH	250-00778
WALL SWITCH COVER PLATE	250-05821

Contact your local Fire Garden™ dealer to purchase replacement parts.

## Troubleshooting Table

<b>Problem:</b>	<b>Possible Cause:</b>	<b>Don't Call for Service Until You:</b>
<b>Appliance Does Not Light and igniter does not Glow Red</b>	<ul style="list-style-type: none"> <li>• Electrical Power Off</li> <li>• Igniter burned out</li> <li>• Burner or burner orifice may be dirty or blocked</li> </ul>	<p>Verify power is on and check the circuit breaker or GFCI.</p> <p>Replace Igniter</p> <p>Contact your dealer for details on removing any debris (spider webs, etc.) from the burner and orifice area.</p>
<b>Appliance Does Not Light and Igniter Glows Red</b>	<ul style="list-style-type: none"> <li>• Gas is Off</li> <li>• Not enough electrical current to the appliance</li> </ul>	<p>Turn Gas On (check shut-off valve)</p> <p>Voltage must be checked with power draw (appliance in startup)</p>
<b>Appliance Lights During Ignition Sequence then Goes Out During Normal Operation</b>	<ul style="list-style-type: none"> <li>• Dirty Air Channel or Burner</li> <li>• Thermopile has worn out</li> </ul>	<p>Remove glass and clean soot from burner, and any air channels. If problem persists, contact the dealer for service.</p> <p>Replace thermopile</p>
<b>Flames are too short</b>	<ul style="list-style-type: none"> <li>• The gas supply pressure to the appliance is too low.</li> </ul>	<p>Depleted LP cylinder.</p> <p>Gas supply lines or gas regulators do not have enough capacity. This may be due to other appliances in the house using up the available capacity, e.g. pool heaters, furnaces, hot water tanks, etc.</p>
<b>Glass is Sooting</b>	<ul style="list-style-type: none"> <li>• Burner or burner orifice may be dirty or blocked</li> <li>• Windy Condition</li> </ul>	<p>Contact your dealer for details on removing any debris (spider webs, etc.) from the burner and orifice area.</p> <p>Wind will influence the flame quality and, if persistent, may lead to sooting on the glass.</p>

# Limited Warranty

Register your TRAVIS INDUSTRIES, INC. Limited 7 Year Warranty online at [traviswarranty.com](http://traviswarranty.com). TRAVIS INDUSTRIES, INC. warrants this gas appliance (appliance is defined as the equipment manufactured by Travis Industries, Inc.) to be defect-free in material and workmanship to the original purchaser from the date of purchase as follows:

Check with your dealer in advance for any costs to you when arranging a warranty call.  
Mileage or service charges are not covered by this warranty. This charge can vary from store to store.

		Warranty Period								Component	
		2 yrs.		5 yrs.		7 yrs.		90 Days			
P=Parts L=Labor		P	L	P	L	P	L	P	L		
		✓	✓	✓	✓	✓					<b>Burner Assembly</b> Burner Pan Assembly, Main Burner Orifice
		✓	✓								<b>Electrical Assembly (within appliance structure)</b> Wire harness, Transformer (sku# 94800830 if purchased with the appliance)
		✓	✓								<b>Gas Control Assembly</b> Solenoid, Ignition control module, Hot surface igniter, Thermopile
		✓	✓								<b>Accessories</b> Glass Wind Guard (Thermal shock only)
		✓	✓								<b>One-Way Freight Allowance</b> One-way freight allowance on pre-authorized repair done at the factory is covered.
								✓			<b>All replacement parts purchased beyond the warranty period</b>

## CONDITIONS & EXCLUSIONS

- This new gas appliance must be installed by a qualified gas appliance technician. It must be installed, operated, and maintained at all times in accordance with the instructions in the Owner's Manual. Any alteration, willful abuse, accident, neglect, alteration, misapplication, or misuse of the product shall nullify this warranty.
- This warranty is non-transferable and is made to the ORIGINAL purchaser, provided that the purchase was made through an authorized TRAVIS dealer.
- Discoloration and some minor expansion, contraction, or movement of certain parts and resulting noise, is normal and not a defect and, therefore, not covered under warranty. The installer must ensure the appliance is burning as per the rating tag at the time of installation. Overfiring (operation above the listed BTU rate) of this appliance can cause serious damage and will nullify this warranty.
- This warranty does not cover damage to the finish, such as scratches, dents, discoloration, rust, or other weather damage, after purchase.
- Travis Industries will not be responsible for inadequate performance caused by environmental conditions such as nearby trees, buildings, rooftops, wind, hills or mountains, or other influences from mechanical systems such as fans, etc.
- This Warranty is void if:
  - The unit has been operated in atmospheres contaminated by chlorine, fluorine, or other damaging chemicals.
  - The unit is subject to submersion in water.
- Exclusions to this warranty include: injury, loss of use, damage, failure to function due to accident, negligence, misuse, improper installation, alteration or adjustment of the manufacturer's settings of components, lack of proper and regular maintenance, damage incurred while the appliance is in transit, alteration, or act of God.
- This warranty excludes damage caused by normal wear and tear, such as discoloration. Also excluded is damage to the unit caused by abuse, improper installation, modification of the unit, drilling of the orifices, or the use of fuel other than that for which the unit is configured. Units are shipped for either natural gas or propane. Confirm fuel configuration with your installer.
- Damage to stainless steel surfaces caused by fingerprints, scratches, melted items, or other external sources left on the stainless steel from the use of cleaners is not covered in this warranty.
- TRAVIS INDUSTRIES, INC. is free of liability for any damages caused by the appliance, as well as inconvenience expenses and materials. Incidental or consequential damages are not covered by this warranty. In some states, the exclusion of incidental or consequential damage may not apply.
- This warranty does not cover any loss or damage incurred by the use or removal of any component or apparatus to or from the gas appliance without the express written permission of TRAVIS INDUSTRIES, INC. and bearing a TRAVIS INDUSTRIES, INC. label of approval.
- Any statement or representation of TRAVIS products and their performance contained in TRAVIS advertising, packaging literature, or printed material is not part of this warranty.
- This warranty is automatically voided if the appliance's serial number has been removed or altered in any way.
- No dealer, distributor, or similar person has the authority to represent or warrant TRAVIS products beyond the terms contained within this warranty. TRAVIS INDUSTRIES, INC. assumes no liability for such warranties or representations.
- Travis Industries will not cover the cost of the removal or re-installation.
- If for any reason any section of this warranty is declared invalid, the balance of the warranty remains in effect and all other clauses shall remain in effect.
- THIS WARRANTY IS THE ONLY WARRANTY SUPPLIED BY TRAVIS INDUSTRIES, INC., THE MANUFACTURER OF THE APPLIANCE. ALL OTHER WARRANTIES, WHETHER EXPRESS OR IMPLIED, ARE HEREBY EXPRESSLY DISCLAIMED AND PURCHASER'S RECOURSE IS EXPRESSLY LIMITED TO THE WARRANTIES SET FORTH HEREIN.**

## IF WARRANTY SERVICE IS NEEDED:

- If you discover a problem that you believe is covered by this warranty, you MUST REPORT it to your TRAVIS dealer WITHIN 30 DAYS, giving them proof of purchase, the purchase date, and the model name and serial number.
- Travis Industries has the option of either repairing or replacing the defective component.
- If your dealer is unable to repair your appliance's defect, he may process a warranty claim through TRAVIS INDUSTRIES, INC., including the name of the dealership where you purchased the appliance, a copy of your receipt showing the date of the appliance's purchase, and the serial number on your appliance. At that time, you may be asked to ship your appliance, freight charges prepaid, to TRAVIS INDUSTRIES, INC. TRAVIS INDUSTRIES, INC., at its option, will repair or replace, free of charge, your TRAVIS appliance if it is found to be defective in material or workmanship within the time frame stated within this warranty. TRAVIS INDUSTRIES, INC. will return your appliance, freight charges prepaid by TRAVIS INDUSTRIES, INC., to your regional distributor, or dealership.



## Wiring Diagram

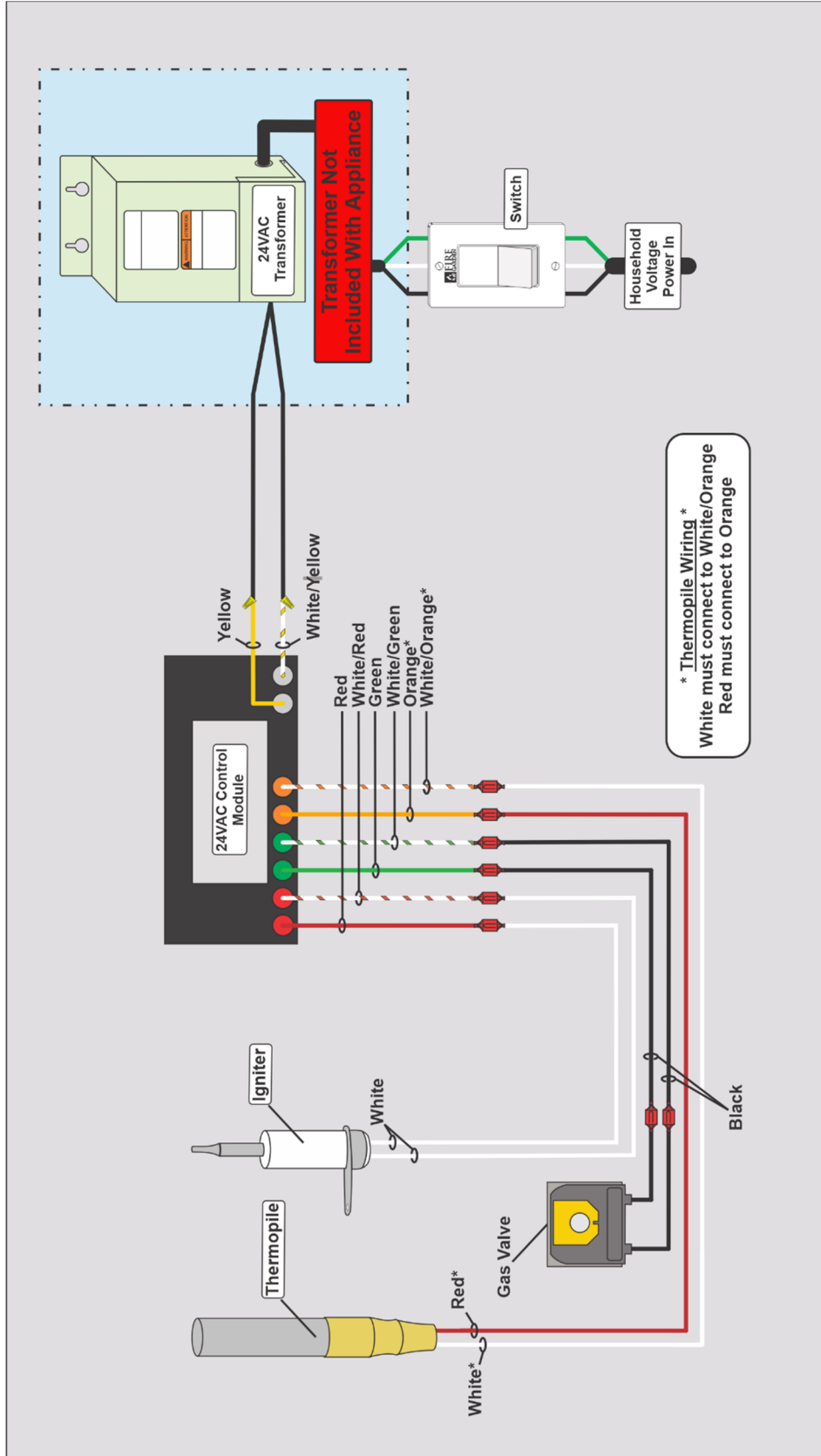





Accessing Components .....	35	Linear Fire Pit Dimensions.....	6
Additional Items Required .....	9	Location of Controls .....	33
Appliance Placement Requirements .....	10	LP Conversion .....	14
Appliance Weight .....	5	Maintaining Your Appliance .....	34
Assembling the Wind Guard .....	28	<b>Multiple Appliances to One Transformer</b> .....	22
Before the First Fire .....	32	Multiple Transformers to One Switch.....	21
Clearances .....	11	Operating Instructions.....	32
Crushed Glass Installation .....	25	Packing List.....	8
<b>Daisy-Chain Wire Length Chart</b> .....	23	Recommended Order of Installation .....	8
<b>Direct-Run Wire Length Chart</b> .....	24	Replacement Parts List.....	38
Electrical Connection Requirements .....	15	Rock Ember Installation .....	26
Electrical Specifications .....	5	Steps for Finalizing the Installation .....	25
Enclosure Ventilation Requirements .....	12	Troubleshooting Table .....	39
Gas Line Requirements .....	13	Tumbled Stone Installation .....	27
Gas Specifications .....	5	Using More than One 24-volt Appliance .....	21
<b>Glass Cleaning</b> .....	34	Winterizing the Appliance .....	37
Installation Warnings.....	7	Yearly Service Procedure .....	37